

Module
FOR B1 & B2 CERTIFICATION

08

BASIC AERODYNAMICS

Aviation Maintenance Technician
Certification Series



- Physics of the Atmosphere
- Aerodynamics
- Theory of Flight
- Flight Stability and Dynamics



MODULE 08

FOR B1 & B2 CERTIFICATION

BASIC AERODYNAMICS

Aviation Maintenance Technician Certification Series



72413 U.S. Hwy 40
Tabernash, CO 80478-0270 USA

www.actechbooks.com

+1 970 726-5111



AVIATION MAINTENANCE TECHNICIAN CERTIFICATION SERIES

Author Thomas Forenz
Layout/Design Michael Amrine

Copyright © 2016 — Aircraft Technical Book Company. All Rights Reserved.

No part of this publication may be reproduced, stored in a retrieval system, transmitted in any form or by any means, electronic, mechanical, photocopying, recording or otherwise, without the prior written permission of the publisher.

To order books or for Customer Service, please call +1 970 726-5111.

www.actechbooks.com

Printed in the United States of America



EASA Part-66 Aviation Maintenance Technician Certification Series

NO COST REVISION/UPDATE SUBSCRIPTION PROGRAM



Complete EASA Part-66 Aviation Maintenance Technician Certification Series

NO COST REVISION/UPDATE PROGRAM

Aircraft Technical Book Company is offering a revision/update program to our customers who purchase an EASA Module from the EASA Aviation Maintenance Technician Certification Series. The update is good for two (2) years from time of registration of any EASA Module or EASA bundled kits. If a revision occurs within two (2) years from date of registration, we will send you the revised pages FREE of cost to the registered email. Go to the link provided at the bottom of this page and fill out the form to be included in the EASA Revision/Update Subscription Program. In an effort to provide quality customer service please let us know if your email you register with changes so we can update our records.

If you have any questions about this process please send an email to: techsupport@actechbooks.com

HERE'S HOW IT WORKS

1. All EASA Module Series textbooks contain an EASA subscription page explaining the subscription update process and provide a web site link to register for the EASA Revision/Update Subscription Program.
2. Go to the link provided below and fill out the web based form with your *first and last name, current email address, and school* if applicable.
3. From the time of purchase, if a revision occurs to the Module you have registered for, a revised PDF file containing the pages with edits will be sent to the registered email provided.
4. Please note that we try to keep our records as current as possible. If your email address provided at time of registration changes please let us know as soon as possible so we can update your account.
5. This service is FREE of charge for two (2) years from date of registration.

LINK TO REGISTER FOR REVISION/UPDATE PROGRAM

<http://www.actechbooks.com/easasub/m08>



WELCOME

The publishers of this Aviation Maintenance Technician Certification Series welcome you to the world of aviation maintenance. As you move towards EASA certification, you are required to gain suitable knowledge and experience in your chosen area. Qualification on basic subjects for each aircraft maintenance license category or subcategory is accomplished in accordance with the following matrix. Where applicable, subjects are indicated by an "X" in the column below the license heading.

For other educational tools created to prepare candidates for licensure, contact Aircraft Technical Book Company.

We wish you good luck and success in your studies and in your aviation career!

EASA LICENSE CATEGORY CHART

Module number and title		A1 Airplane Turbine	B1.1 Airplane Turbine	B1.2 Airplane Piston	B1.3 Helicopter Turbine	B2 Avionics
1	Mathematics	X	X	X	X	X
2	Physics	X	X	X	X	X
3	Electrical Fundamentals	X	X	X	X	X
4	Electronic Fundamentals		X	X	X	X
5	Digital Techniques / Electronic Instrument Systems	X	X	X	X	X
6	Materials and Hardware	X	X	X	X	X
7A	Maintenance Practices	X	X	X	X	X
8	Basic Aerodynamics	X	X	X	X	X
9A	Human Factors	X	X	X	X	X
10	Aviation Legislation	X	X	X	X	X
11A	Turbine Aeroplane Aerodynamics, Structures and Systems	X	X			
11B	Piston Aeroplane Aerodynamics, Structures and Systems			X		
12	Helicopter Aerodynamics, Structures and Systems				X	
13	Aircraft Aerodynamics, Structures and Systems					X
14	Propulsion					X
15	Gas Turbine Engine	X	X		X	
16	Piston Engine			X		
17A	Propeller	X	X	X		

FORWARD

PART-66 and the Acceptable Means of Compliance (AMC) and Guidance Material (GM) of the European Aviation Safety Agency (EASA) Regulation (EC) No. 1321/2014, Appendix 1 to the Implementing Rules establishes the Basic Knowledge Requirements for those seeking an aircraft maintenance license. The information in this Module of the Aviation Maintenance Technical Certification Series published by the Aircraft Technical Book Company meets or exceeds the breadth and depth of knowledge subject matter referenced in Appendix 1 of the Implementing Rules. However, the order of the material presented is at the discretion of the editor in an effort to convey the required knowledge in the most sequential and comprehensible manner. Knowledge levels required for Category A1, B1, B2, and B3 aircraft maintenance licenses remain unchanged from those listed in Appendix 1 Basic Knowledge Requirements. Tables from Appendix 1 Basic Knowledge Requirements are reproduced at the beginning of each module in the series and again at the beginning of each Sub-Module.

How numbers are written in this book:

This book uses the International Civil Aviation Organization (ICAO) standard of writing numbers. This method displays large numbers by adding a space between each group of 3 digits. This is opposed to the American method which uses commas and the European method which uses periods. For example, the number one million is expressed as so:

ICAO Standard	1 000 000
European Standard	1.000.000
American Standard	1,000,000

SI Units:

The International System of Units (SI) developed and maintained by the General Conference of Weights and Measures (CGPM) shall be used as the standard system of units of measurement for all aspects of international civil aviation air and ground operations.

Prefixes:

The prefixes and symbols listed in the table below shall be used to form names and symbols of the decimal multiples and submultiples of International System of Units (SI) units.

MULTIPLICATION FACTOR	PREFIX	SYMBOL
1 000 000 000 000 000 000 = 10^{18}	exa	E
1 000 000 000 000 000 = 10^{15}	peta	P
1 000 000 000 000 = 10^{12}	tera	T
1 000 000 000 = 10^9	giga	G
1 000 000 = 10^6	mega	M
1 000 = 10^3	kilo	k
100 = 10^2	hecto	h
10 = 10^1	deca	da
0.1 = 10^{-1}	deci	d
0.01 = 10^{-2}	centi	c
0.001 = 10^{-3}	milli	m
0.000 001 = 10^{-6}	micro	μ
0.000 000 001 = 10^{-9}	nano	n
0.000 000 000 001 = 10^{-12}	pico	p
0.000 000 000 000 001 = 10^{-15}	femto	f
0.000 000 000 000 000 001 = 10^{-18}	atto	a

International System of Units (SI) Prefixes

This module includes an examination of the discipline known as aerodynamics. Even though a technician may never fly in an aircraft, the aircraft upon which he or she works conforms to the rules of aerodynamics and it is the technician's responsibility to ensure it does so at all times. Very subtle changes to the physical structure of the aircraft can cause dramatic changes in flight characteristics. The EASA certified maintenance professional must be familiar with the basic aspects of aerodynamics to exercise the best judgment of aircraft airworthiness and aerodynamic functioning.

Module 08 Syllabus as outlined in PART-66, Appendix 1.

CERTIFICATION CATEGORY →	LEVELS	
	B1	B2
Sub-Module 01 - Physics of the Atmosphere International Standard Atmosphere (ISA), application to aerodynamics.	2	2
Sub-Module 02 - Aerodynamics Airflow around a body; Boundary layer, laminar and turbulent flow, free stream flow, relative airflow, upwash and downwash, vortices, stagnation; The terms: camber, chord, mean aerodynamic chord, profile (parasite) drag, induced drag, center of pressure, angle of attack, wash in and wash out, fineness ratio, wing shape and aspect ratio; Thrust, Weight, Aerodynamic Resultant; Generation of Lift and Drag: Angle of Attack, Lift coefficient, Drag coefficient, polar curve, stall; Aerofoil contamination including ice, snow, frost.	2	2
Sub-Module 03 - Theory of Flight Relationship between lift, weight, thrust and drag; Glide ratio; Steady state flights, performance; Theory of the turn; Influence of load factor: stall, flight envelope and structural limitations; Lift augmentation.	2	2
Sub-Module 04 - Flight Stability and Dynamics Longitudinal, lateral and directional stability (active and passive).	2	2

REVISION LOG

VERSION	ISSUE DATE	DESCRIPTION OF CHANGE	MODIFICATION DATE
001	2015 01	Module Creation and Release	
002	2016 07	Minor Style Revisions and Reissue	2016 07

ACKNOWLEDGMENTS

BASIC AERODYNAMICS

Welcome iii
 Forward..... iv
 Preface..... v
 Revision Log..... vi
 Acknowledgments vi

SUB-MODULE 01

PHYSICS OF THE ATMOSPHERE

Knowledge Requirements 1.1
 Basic Aerodynamics 1.2
 Physics of the Atmosphere 1.2
 Pressure 1.2
 Density 1.4
 Humidity 1.4
 Temperature and Altitude 1.4
 International Standard Atmosphere 1.5
 Questions 1.7
 Answers 1.8

SUB-MODULE 02

AERODYNAMICS

Knowledge Requirements 2.1
 Aerodynamics 2.2
 Velocity and Acceleration..... 2.2
 Newton’s Laws of Motion 2.2
 Bernoulli’s Principle and Subsonic Flow 2.3
 Boundary Layer and Friction Effects..... 2.4
 Planform and Vortices 2.7
 Aerodynamic Terms 2.7
 Airfoils 2.8
 Shape of the Airfoil 2.8
 Airfoil Contamination..... 2.9
 Thrust, Weight, Lift and Drag..... 2.10
 Aerodynamic Resultant 2.10
 Generation of Lift and Drag 2.11
 Lift and Drag Coefficients 2.11
 Lift/Drag Ratio 2.11
 Angle of Attack (AOA) 2.12
 Drag 2.14
 Parasite Drag 2.14
 Form Drag..... 2.14
 Friction Drag..... 2.14
 Interference Drag 2.15
 Induced Drag 2.15
 Wave Drag 2.16
 Drag and Airspeed..... 2.17

Questions 2.19
 Answers 2.20

SUB-MODULE 03

THEORY OF FLIGHT

Knowledge Requirements 3.1
 Relationship Between Lift, Weight, Thrust and Drag 3.2
 Weight, Center of Gravity, Lift 3.2
 Lift 3.2
 Thrust and Drag..... 3.3
 Glide Ratio 3.3
 Polar Curve..... 3.5
 Aerodynamic Forces in Turns 3.5
 Stalls 3.7
 Flight Envelope and Structural Limitations 3.9
 Load Factors 3.9
 Load Factors in Aircraft Design 3.9
 High Speed Flight 3.10
 Subsonic vs Supersonic Flow..... 3.10
 Speed Ranges 3.11
 Mach Number vs Airspeed 3.12
 Shock Waves 3.13
 Sweepback 3.14
 Lift Augmentation 3.16
 Flaps..... 3.16
 Leading Edge Devices..... 3.17
 Fixed Airflow Devices 3.18
 Questions 3.19
 Answers 3.20

SUB-MODULE 04

FLIGHT STABILITY AND DYNAMICS

Knowledge Requirements 4.1
 The Axes of an Aircraft 4.2
 Stability and Control 4.3
 Static Stability 4.3
 Longitudinal Stability (Pitching) 4.4
 Lateral Stability (Rolling) 4.7
 Dihedral 4.7
 Sweepback..... 4.7
 Keel Effect and Weight Distribution 4.7
 Vertical (Directional)..... 4.8
 Stability (Yawing) 4.8
 Free Directional Oscillations (Dutch Roll) 4.9
 Questions 4.11
 Answers 4.12

CONTENTS

Acronym Index.....	A.1
Glossary	G.1
Index	I.1



BASIC AERODYNAMICS

PHYSICS OF THE ATMOSPHERE

SUB-MODULE 01

PART-66 SYLLABUS LEVELS

CERTIFICATION CATEGORY →

B1 B2

Sub-Module 01

PHYSICS OF THE ATMOSPHERE

Knowledge Requirements

8.1 - Physics of the Atmosphere

International Standard Atmosphere (ISA), application to aerodynamics.

2 2

Level 2

A general knowledge of the theoretical and practical aspects of the subject and an ability to apply that knowledge.

Objectives:

- (a) The applicant should be able to understand the theoretical fundamentals of the subject.
- (b) The applicant should be able to give a general description of the subject using, as appropriate, typical examples.
- (c) The applicant should be able to use mathematical formula in conjunction with physical laws describing the subject.
- (d) The applicant should be able to read and understand sketches, drawings and schematics describing the subject.
- (e) The applicant should be able to apply his knowledge in a practical manner using detailed procedures.

BASIC AERODYNAMICS

Three topics that are directly related to the manufacture, operation, and repair of aircraft are: aerodynamics, aircraft assembly, and rigging. Each of these subject areas, though studied separately, eventually connect to provide a scientific and physical understanding of how an aircraft is prepared for flight. A logical place to start with these three topics is the study of basic aerodynamics. By studying aerodynamics, a person becomes familiar with the fundamentals of aircraft flight.

Aerodynamics is the study of the dynamics of gases. The interaction between a moving object and the atmosphere is the primary interest in this module. The movement of an object and its reaction to the air flow around it can be seen when watching water passing the bow of a ship. The major difference between water and air is that air is compressible and water is incompressible. The action of the airflow over a body is a large part of the study of aerodynamics. Some common aircraft terms, such as rudder, hull, water line, and keel beam, were borrowed from nautical terms.

Many textbooks have been written about the aerodynamics of aircraft flight. It is not necessary for an airframe and powerplant technician to be as knowledgeable as an aeronautical design engineer

about aerodynamics. The technician must be able to understand the relationships between how an aircraft performs in flight and its reaction to the forces acting on its structural parts. Understanding why aircraft are designed with particular types of primary and secondary control systems and why the surfaces must be aerodynamically smooth becomes essential when maintaining today's complex aircraft.

The theory of flight should be described in terms of the laws of flight because what happens to an aircraft when it flies is not based upon assumptions, but upon a series of facts. Aerodynamics is a study of laws which have been proven to be the physical reasons why an airplane flies. The term aerodynamics is derived from the combination of two Greek words: "aero," meaning air, and "dyne," meaning force of power. Thus, when "aero" joins "dynamics" the result is "*aerodynamics*"—the study of objects in motion through the air and the forces that produce or change such motion.

Aerodynamically, an aircraft can be defined as an object traveling through space that is affected by the changes in atmospheric conditions. To state it another way, aerodynamics covers the relationships between the aircraft, relative wind, and atmosphere.

PHYSICS OF THE ATMOSPHERE

Before examining the fundamental laws of flight, several basic facts must be considered. An aircraft operates in the air. Therefore, those properties of air that affect the control and performance of an aircraft must be understood.

The air in the earth's atmosphere is composed mostly of nitrogen and oxygen. Air is considered a fluid because it fits the definition of a substance that has the ability to flow or assume the shape of the container in which it is enclosed. If the container is heated, pressure increases; if cooled, the pressure decreases. The weight of air is heaviest at sea level where it has been compressed by all of the air above. This compression of air is called atmospheric pressure.

PRESSURE

Atmospheric pressure is usually defined as the force exerted against the earth's surface by the weight of the air above that surface. Weight is force applied to an area that results in pressure. Force (F) equals area (A) times pressure (P), or $F = AP$. Therefore, to find the amount of pressure, divide area into force ($P = F/A$). A column of air (one square inch) extending from sea level to the top of the atmosphere weighs approximately 14.7 pounds; therefore, atmospheric pressure is stated in pounds per square inch (psi). Thus, atmospheric pressure at sea level is 14.7 psi. (*Figure 1-1*)

Atmospheric pressure is measured with an instrument called a barometer, composed of mercury in a tube that records atmospheric pressure in inches of mercury (Hg). (*Figure 1-2*)

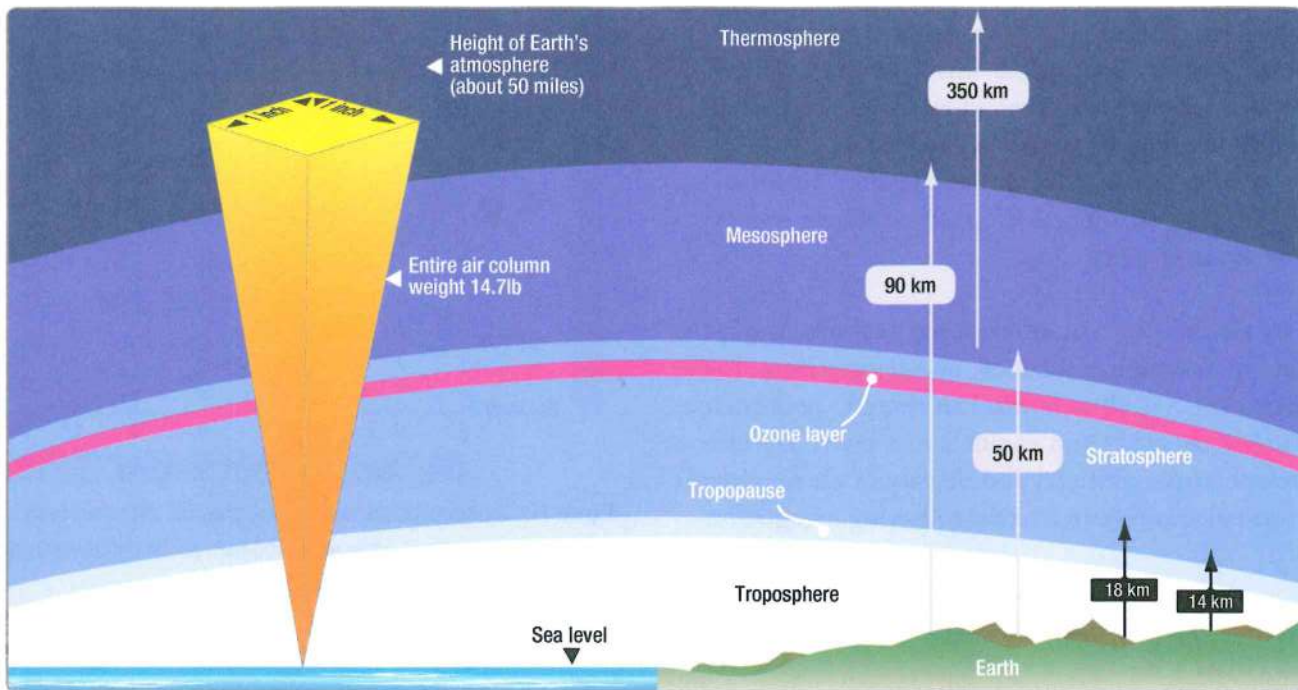

Figure 1-1. The weight exerted by a 1 square inch column of air stretching from sea level to the top of the atmosphere is what is measured when it is said that atmospheric pressure is equal to 14.7 pounds per square inch.

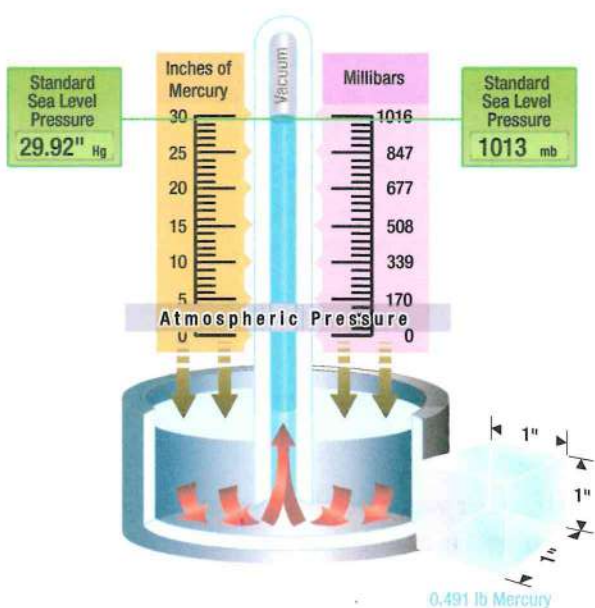

Figure 1-2. Barometer used to measure atmospheric pressure.

The standard measurement in aviation altimeters and U.S. weather reports has been "Hg". However, worldwide weather maps and some non-U.S., manufactured aircraft instruments indicate pressure in millibars (mb), an SI metric unit.

Aviators often interchange references to atmospheric pressure between linear displacement (e.g., inches of mercury) and units of force (e.g., psi). Over the years, meteorology has shifted its use of linear displacement representation of atmospheric pressure to units of force. The unit of force nearly universally used today to represent atmospheric pressure in meteorology is the hectopascal (hPa). A pascal is a SI metric unit that expresses force in Newtons per square meter. A hectopascal is 100 Pascals. 1 013.2 hPa is equal to 14.7 psi which is equal to 29.92 Hg. (Figure 1-3)

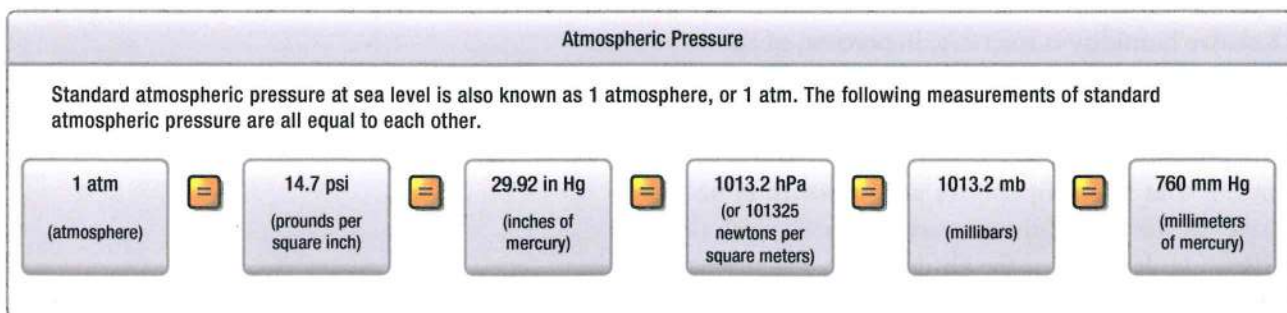

Figure 1-3. Various equivalent representations of atmospheric pressure at sea level.

Atmospheric pressure decreases with increasing altitude. The simplest explanation for this is that the column of air that is weighed is shorter. How the pressure changes for a given altitude is shown in *Figure 1-4*. The decrease in pressure is a rapid one and, at 50 000 feet, the atmospheric pressure has dropped to almost one-tenth of the sea level value.

As an aircraft ascends, atmospheric pressure drops, the quantity of oxygen decreases, and temperature drops. These changes in altitude affect an aircraft's performance in such areas as lift and engine horsepower. The effects of temperature, altitude, and density of air on aircraft performance are covered in the following paragraphs.

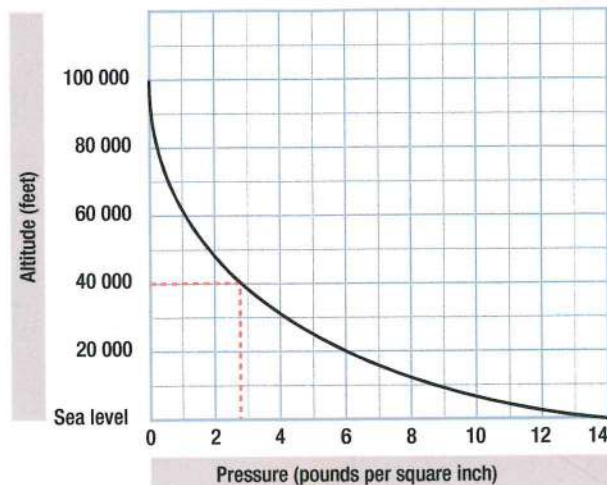

Figure 1-4. Atmospheric pressure decreasing with altitude. At sea level the pressure is 14.7 psi, while at 40 000 feet, as the dotted lines show, the pressure is only 2.72 psi.

DENSITY

Density is weight per unit of volume. Since air is a mixture of gases, it can be compressed. If the air in one container is under half as much pressure as an equal amount of air in an identical container, the air under greater pressure is twice as dense as that in the other container. For the equal weight of air, that which is under the greater pressure occupies only half the volume of that under half the pressure.

The density of gases is governed by the following rules:

1. Density varies in direct proportion with the pressure.
2. Density varies inversely with the temperature.

HUMIDITY

Humidity is the amount of water vapor in the air. The maximum amount of water vapor that air can hold varies with the temperature. The higher the temperature of the air, the more water vapor it can absorb.

1. Absolute humidity is the weight of water vapor in a unit volume of air.
2. Relative humidity is the ratio, in percent, of the moisture actually in the air to the moisture it would hold if it were saturated at the same temperature and pressure.

Assuming that the temperature and pressure remain the same, the density of the air varies inversely with the humidity. On damp days, the air density is less than on dry days. For this reason, an aircraft requires a longer runway for takeoff on damp days than it does on dry days.

Thus, air at high altitudes is less dense than air at low altitudes, and a mass of hot air is less dense than a mass of cool air. Changes in density affect the aerodynamic performance of aircraft with the same horsepower. An aircraft can fly faster at a high altitude where the air density is low than at a low altitude where the density is greater. This is because air offers less resistance to the aircraft when it contains a smaller number of air particles per unit of volume.

By itself, water vapor weighs approximately five-eighths as much as an equal amount of perfectly dry air. Therefore, when air contains water vapor, it is not as heavy as dry air containing no moisture.

TEMPERATURE AND ALTITUDE

Temperature variations in the atmosphere are of concern to aviators. Weather systems produce changes in temperature near the earth's surface. Temperature also changes as altitude is increased. The troposphere is the lowest layer of the atmosphere. On average, it ranges from the earth's surface to about 38 000 feet above it. Over the poles, the troposphere extends to only 25 000 – 30 000 feet and, at the equator, it may extend to around 60 000 feet. This oblong nature of the troposphere is illustrated in *Figure 1-5*.

Most civilian aviation takes place in the troposphere in which temperature decreases as altitude increases. The rate of change is somewhat constant at about $-2\text{ }^{\circ}\text{C}$ or $-3.5\text{ }^{\circ}\text{F}$ for every 1 000 feet of increase in altitude. The upper boundary of the troposphere is the tropopause. It is characterized as a zone of relatively constant temperature of $-57\text{ }^{\circ}\text{C}$ or $-69\text{ }^{\circ}\text{F}$.

Above the tropopause lies the stratosphere. Temperature increases with altitude in the stratosphere to near $0\text{ }^{\circ}\text{C}$ before decreasing again in the mesosphere, which lies above it. The stratosphere contains the ozone layer that protects the earth's inhabitants from harmful UV (Ultraviolet) rays. Some civilian flights and numerous military flights occur in the stratosphere.

Figure 1-6 diagrams the temperature variations in different layers of the atmosphere.

As stated, density varies inversely with temperature or, as temperature increases, air density decreases. This phenomenon explains why on very warm days, aircraft takeoff performance decreases. The air available for combustion is less dense. Air with low density contains less total oxygen to combine with the fuel.

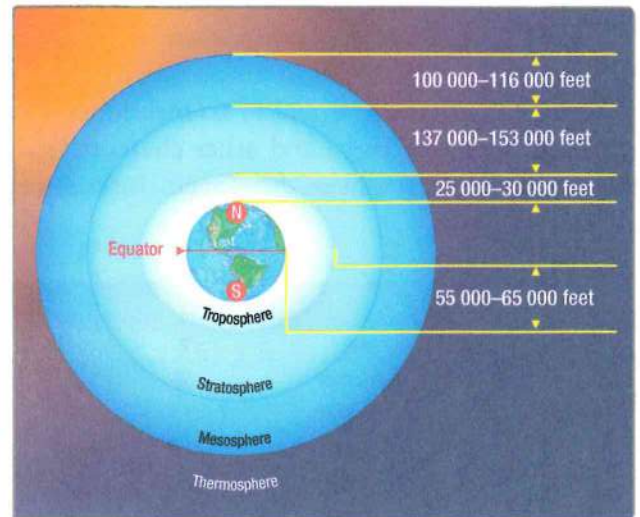

Figure 1-5. The troposphere extends higher above the earth's surface at the equator than it does at the poles.

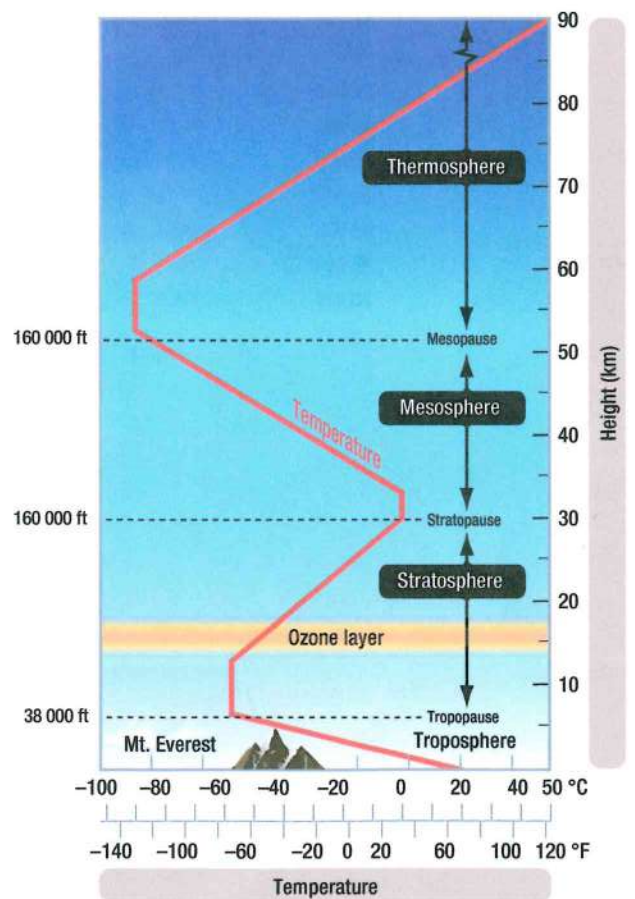

Figure 1-6. The atmospheric layers with temperature changes depicted by the red line.

INTERNATIONAL STANDARD ATMOSPHERE

The atmosphere is never at rest. Pressure, temperature, humidity, and density of the air are continuously changing. To provide a basis for theoretical calculations, performance comparisons and instrumentation parity, standard values for these and other characteristic of the atmosphere have been developed. International

Civil Aviation Organization (ICAO), International Organization for Standardization (ISO), and various governments establish and publish the values known as the International Standard Atmosphere. (*Figure 1-7*)

ALTITUDE	TEMPERATURE		PRESSURE		DENSITY		
	Feet	°F	°C	psi	hPa	slug/ft ³	kg/m ³
Sea Level		59	15	14.67	1013.53	0.002378	1.23
1000		55.4	13	14.17	977.16	0.002309	1.19
2000		51.9	11	13.66	941.82	0.002242	1.15
3000		48.3	9.1	13.17	908.11	0.002176	1.12
4000		44.7	7.1	12.69	874.94	0.002112	1.09
5000		41.2	5.1	12.05	843.07	0.002049	1.06
6000		37.6	3.1	11.78	812.2	0.001988	1.02
7000		34	1.1	11.34	781.85	0.001928	0.99
8000		30.5	-0.9	10.92	752.91	0.001869	0.96
9000		26.9	-2.8	10.5	724.28	0.001812	0.93
10 000		23.3	-4.8	10.11	697.06	0.001756	0.9
15 000		5.5	-14.7	8.3	571.82	0.001496	0.77
20 000		-12.3	-24.6	6.75	465.4	0.001267	0.65
25 000		-30.2	-34.5	5.46	376.01	0.001066	0.55
30 000		-48	-44.4	4.37	301.3	0.000891	0.46
35 000		-65.8	-54.3	3.47	238.42	0.000738	0.38
40 000		-69.7	-56.5	2.72	187.54	0.000587	0.3
45 000		-69.7	-56.5	2.15	147.48	0.000462	0.24
50 000		-69.7	-56.5	1.68	115.83	0.000362	0.19

Figure 1-7. The International Standard Atmosphere.

Question: 1-1

Atmospheric pressure is measured with an instrument called a _____.

Question: 1-3

In which layer of the atmosphere does most civilian aviation take place?

Question: 1-2

An aircraft can fly _____ at a high altitude where the air density is low than at a low altitude where the air density is greater.

ANSWERS

Answer: 1-1
barometer.

Answer: 1-3
Troposphere.

Answer: 1-2
faster.



BASIC AERODYNAMICS

AERODYNAMICS

SUB-MODULE 02

PART-66 SYLLABUS LEVELS
CERTIFICATION CATEGORY → B1 B2

AERODYNAMICS

Sub-Module 02

AERODYNAMICS

Knowledge Requirements

8.2 - Aerodynamics

Airflow around a body;

Boundary layer, laminar and turbulent flow, free stream flow, relative airflow, upwash and downwash, vortices, stagnation;

The terms: camber, chord, mean aerodynamic chord, profile (parasite) drag, induced drag, center of pressure, angle of attack, wash in and wash out, fineness ratio, wing shape and aspect ratio;

Thrust, Weight, Aerodynamic Resultant;

Generation of Lift and Drag: Angle of Attack, Lift coefficient, Drag coefficient, polar curve, stall;

Aerofoil contamination including ice, snow, frost.

2 2

Level 2

A general knowledge of the theoretical and practical aspects of the subject and an ability to apply that knowledge.

Objectives:

- (a) The applicant should be able to understand the theoretical fundamentals of the subject.
- (b) The applicant should be able to give a general description of the subject using, as appropriate, typical examples.
- (c) The applicant should be able to use mathematical formula in conjunction with physical laws describing the subject.
- (d) The applicant should be able to read and understand sketches, drawings and schematics describing the subject.
- (e) The applicant should be able to apply his knowledge in a practical manner using detailed procedures.

AERODYNAMICS

The law of conservation of energy states that energy may neither be created nor destroyed. Motion is the act or process of changing place or position. An object may be in motion with respect to one object and motionless with respect to another. For example, a person sitting quietly in an aircraft flying at 200 knots is at rest or motionless with respect to the aircraft; however, the person and the aircraft are in motion with respect to the air and to the earth.

Air has no force or power, except pressure, unless it is in motion. When it is moving, however, its force becomes apparent. A moving object in motionless air has a force exerted on it as a result of its own motion. It makes no difference in the effect then, whether an object is moving with respect to the air or the air is moving with respect to the object. The flow of air around an object caused by the movement of either the air or the object, or both, is called the relative wind.

VELOCITY AND ACCELERATION

The terms *speed* and *velocity* are often used interchangeably but they do not have the same meaning. *Speed* is the rate of motion in relation to time, and *velocity* is the rate of motion in a particular direction in relation to time.

An aircraft starts from New York City and flies 10 hours at an average speed of 260 kilometers per hour (kph). At the end of this time, the aircraft may be over the Atlantic Ocean, Canada the Gulf of Mexico, or, if its flight were in a circular path, it may even be back over New York City. If this same aircraft flew at a velocity of

260 kph in a southwestward direction, it would arrive in Dallas, TX in about 10 hours. Only the rate of motion is indicated in the first example and denotes the speed of the aircraft. In the last example, the particular direction is included with the rate of motion, thus, denoting the velocity of the aircraft.

Acceleration is defined as the rate of change of velocity. An aircraft increasing in velocity is an example of positive acceleration, while another aircraft reducing its velocity is an example of negative acceleration, or deceleration.

NEWTON'S LAWS OF MOTION

The fundamental laws governing the action of air about a wing are known as Newton's laws of motion.

Newton's first law is normally referred to as the law of inertia. It simply states that a body at rest does not move unless force is applied to it. If a body is moving at uniform speed in a straight line, force must be applied to increase or decrease the speed.

According to Newton's law, since air has mass, it is a body. When an aircraft is on the ground with its engines off, inertia keeps the aircraft at rest. An aircraft is moved from its state of rest by the thrust force created by a propeller, or by the expanding exhaust, or both. When an aircraft is flying at uniform speed in a straight line, inertia tends to keep the aircraft moving. Some external force is required to change the aircraft from its path of flight.

Newton's second law states that if a body moving with uniform speed is acted upon by an external

force, the change of motion is proportional to the amount of the force, and motion takes place in the direction in which the force acts. This law may be stated mathematically as follows:

$$\text{Force} = \text{mass} \times \text{acceleration} (F = ma)$$

If an aircraft is flying against a headwind, it is slowed down. If the wind is coming from either side of the aircraft's heading, the aircraft is pushed off course unless the pilot takes corrective action against the wind direction.

Newton's third law is the law of action and reaction. This law states that for every action (force) there is an equal and opposite reaction (force). This law can be illustrated by the example of firing a gun. The action is the forward movement of the bullet while the reaction is the backward recoil of the gun. The three laws of motion that have been discussed apply to the theory of flight. In many cases, all three laws may be operating on an aircraft at the same time.

BERNOULLI'S PRINCIPLE AND SUBSONIC FLOW

Bernoulli's principle states that when a fluid (air) flowing through a tube reaches a constriction, or narrowing, of the tube, the speed of the fluid flowing through that constriction increases and its pressure decreases. The cambered (curved) surface of an airfoil (wing) affects the airflow exactly as a constriction in a tube affects airflow. (Figure 2-2) Diagram A of Figure 2-1 illustrates the effect of air passing through a constriction in a tube. In B, air is flowing past a cambered surface, such as an airfoil, and the effect is similar to that of air passing through a restriction.

An *airfoil* is a surface designed to obtain lift from the air through which it moves. As the air flows over the curved upper surface of an airfoil, its velocity increases and its pressure decreases; an area of low pressure is formed. There is an area of greater pressure on the lower surface of the airfoil, and this greater pressure tends to move the wing upward. The difference in pressure between the upper and lower surfaces of the wing is called *lift*. Three-fourths of the total lift of an airfoil is the result of the decrease in pressure over the upper surface. The impact of air on the lower surface of an airfoil produces the other one-fourth of the total lift.

Note that in order to fit the model of Bernoulli's Principle, the airflow over the wing surfaces must be laminar. Laminar air flow refers to airflow that is flowing

in a consistent smooth stream. Turbulent flow is also possible. This is where the air flowing over the surface no longer so closely adheres to it. The flow is thicker and faster, however, some lift is produced. When the airflow actually separates from the surface of a wing, a different type of turbulence occurs. This type of turbulence does not produce lift and Bernoulli's Principle does not apply. More discussion of these phenomena occur below in the section entitled Boundary Layer and Friction Effects.

Free stream airflow is air flowing without obstruction before it engages the aircraft structure. The velocity of the free stream flow is equal to the speed aircraft. The pressure of the free stream airflow is static pressure. When the free stream flow arrives at the aircraft structure, such as the wing, it must flow around the surface areas. As it does so, the pressure and velocity of the air change depending on the shape of the wing. There is a point in front of the structure, however, where the velocity of the air is zero. This is known as the point of stagnation.

Typical airflow patterns show the relationship between static pressure and velocity defined by Bernoulli. In aerodynamics, when positive pressure is mentioned, it refers to pressures above atmospheric pressure. Negative pressure or suction pressure is lower than atmospheric pressure. Any object placed in an airstream will have

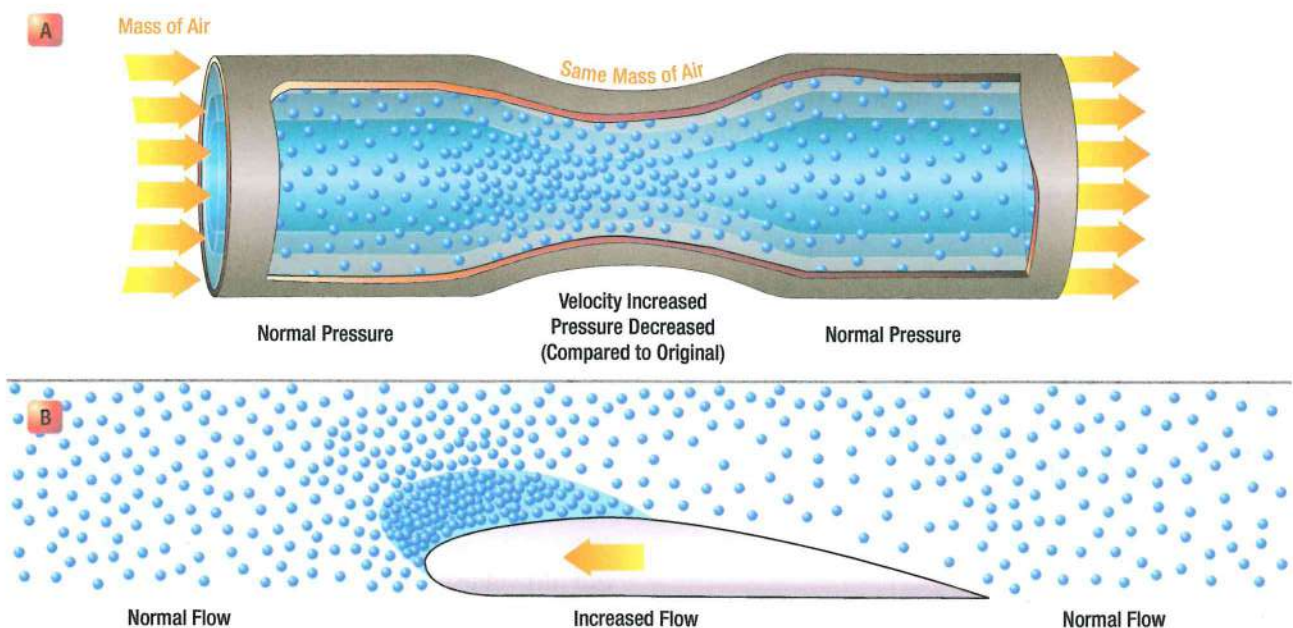

Figure 2-1. Bernoulli's Principle.

the air impact or stagnate at some point near the leading edge. The pressure at this point of stagnation will be an absolute static pressure equal to the total pressure of the airstream. In other words, the static pressure at the stagnation point will be greater than the atmospheric pressure by the amount of the dynamic pressure of the airstream. As the flow divides and proceeds around the object, the increases in local velocity produce decreases in static pressure. This procedure of flow is best illustrated by the flow patterns and pressure distributions of *Figure 2-2*.

Note that the "streamlines" in the diagram show the velocity of the airflow. When they are close together, high velocity exists at that point and when they are far apart, low velocity exists at that point. The vector arrows in the diagram show the magnitude and direction of the low pressure caused by the increased velocity of the airflow.

Because the object in *Figure 2-2* is a symmetrical airfoil, the relative airflow striking it flows above and below the airfoil in the same manner. The pressures are the same and no lift is produced. By reshaping the airfoil or by tilting it in relation to the relative airflow, uneven flow over the upper and lower surfaces occurs. This causes uneven pressure above and below the airfoil which results in the creation of lift. Simply by tilting the same symmetrical airfoil, an increase in upper surface suction occurs and the decreased in velocity on the lower surface causes a decrease in lower surface suction. Also, upwash is generated ahead of the airfoil, the forward stagnation point moves under the leading edge, and a downwash is evident aft of the airfoil. (Upwash and downwash are the deflection directions of the air as it negotiates its path around the airfoil.) The pressure distribution on

the airfoil now provides a net force perpendicular to the airstream in the upward direct. This is lift. (*Figure 2-3*) The creation of lift is discussed in greater detail below.

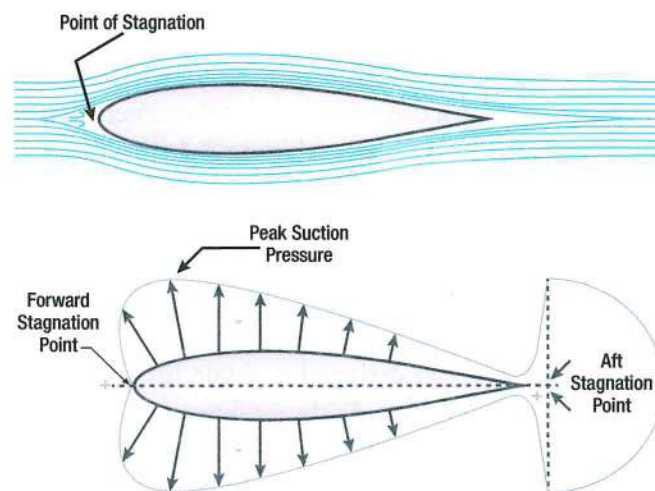

Figure 2-2. Velocity distribution of airflow over a symmetrical airfoil (top); and the resulting pressure (bottom).

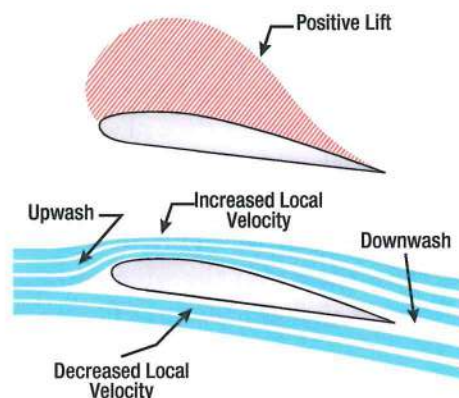

Figure 2-3. Uneven airflow, uneven pressure, up-wash and down-wash are all caused by tilting the airfoil in relation to the free stream airflow.

BOUNDARY LAYER AND FRICTION EFFECTS

In the study of physics and fluid mechanics, a *boundary layer* is that layer of fluid in the immediate vicinity of a bounding surface. In relation to an aircraft, the boundary layer is the part of the airflow closest to the surface of the aircraft. In designing high-performance aircraft, considerable attention is paid to controlling the behavior of the boundary layer to minimize pressure drag and skin friction drag.

Because air has viscosity (internal resistance to flow), air encounters resistance to flow over a surface. The

viscous nature of airflow reduces the local velocities on a surface and accounts for the drag of skin friction. The retardation of air particles due to viscosity is greatest immediately adjacent to the surface. At the very surface of an object, the air particles are slowed to a relative velocity of near zero. Above this area other particles experience successively smaller retardation until finally, at some distance above surface, the local velocity reaches the full value of the airstream above the surface.

This layer of air over the surface which shows local retardation of airflow from viscosity is the boundary layer. The characteristics of this boundary layer are illustrated in *Figure 2-4* with the flow of air over a smooth flat plate.

The beginning flow on a smooth surface gives evidence of a very thin boundary layer with the flow occurring in smooth laminations. The boundary layer flow near the leading edge is similar to layers or laminations of air sliding smoothly over one another. The term for this type of flow is the "laminar" boundary layer as mentioned previously. This smooth laminar flow exists without the air particles moving from a given elevation above the surface.

As the flow continues back from the leading edge, friction forces in the boundary layer continue to dissipate energy of the airstream and the laminar boundary layer increases in thickness with distance from the leading edge. After some distance back from the leading edge, the laminar boundary layer begins an oscillatory disturbance which is unstable. A waviness occurs in the laminar boundary layer which ultimately grows larger and more severe and destroys the smooth

laminar flow. Thus, a transition takes place in which the laminar boundary layer decays into a "turbulent" boundary layer. The same sort of transition can be noticed in the smoke from a cigarette in still air. At first, the smoke ribbon is smooth and laminar, then it develops a definite waviness and decays into a random turbulent smoke pattern.

As soon as the transition to the turbulent boundary layer takes place, the boundary layer thickens and grows at a more rapid rate. (The small scale, turbulent flow within the boundary layer should not be confused with the large scale turbulence associated with airflow separation.) The flow in the turbulent boundary layer allows the air particles to travel from one layer to another producing an energy exchange. However, some small laminar flow continues to exist in the very lower levels of the turbulent boundary layer and is referred to as the "laminar sub-layer."

The turbulence which exists in the turbulent boundary layer allows determination of the point of transition by several means. Since the turbulent boundary layer transfers heat more easily than the laminar layer, frost, water, and oil films will be removed more rapidly from

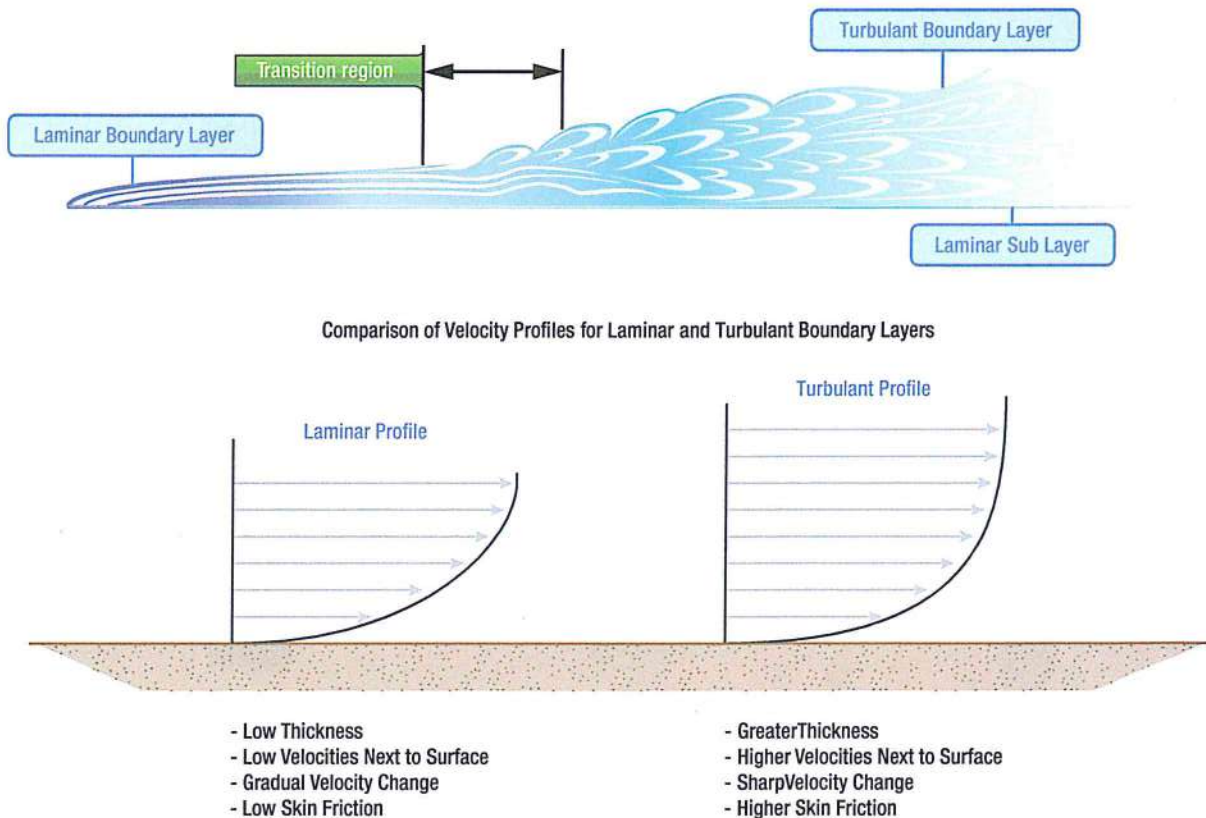

Figure 2-4. Boundary Layer Characteristics.

the area aft of the *transition point*. Also, a small probe may be attached to a stethoscope and positioned at various points along a surface. When the probe is in the laminar area, a low "hiss" will be heard. When the probe is in the turbulent area, a sharp "crackling" will be audible. In order to compare the characteristics of the laminar and turbulent boundary layers, the velocity profiles (the variation of boundary layer velocity with height above the surface) should be compared under conditions which could produce either laminar or turbulent flow. The typical laminar and turbulent profiles are shown in *Figure 2-4*. The velocity profile of the turbulent boundary layer shows a much sharper initial change of velocity but a greater height (or boundary layer thickness) required to reach the free stream velocity.

As a result of these differences, a comparison shows:

1. The turbulent boundary layer has a fuller velocity profile and has higher local velocities immediately adjacent to the surface. The turbulent boundary layer has higher kinetic energy in the airflow next to the surface.
2. At the surface, the laminar boundary layer has the less rapid change of velocity with distance above the surface. Since the shearing stress is proportional to the velocity gradient, the lower velocity gradient of the laminar boundary layer is evidence of a lower friction drag on the surface. In conditions of flow where a turbulent and a laminar boundary layer can exist, the laminar skin friction is about one-third that for turbulent flow. And while the low friction drag of the laminar boundary layer is desirable, the transition to turbulent boundary layer flow is natural and largely inevitable.

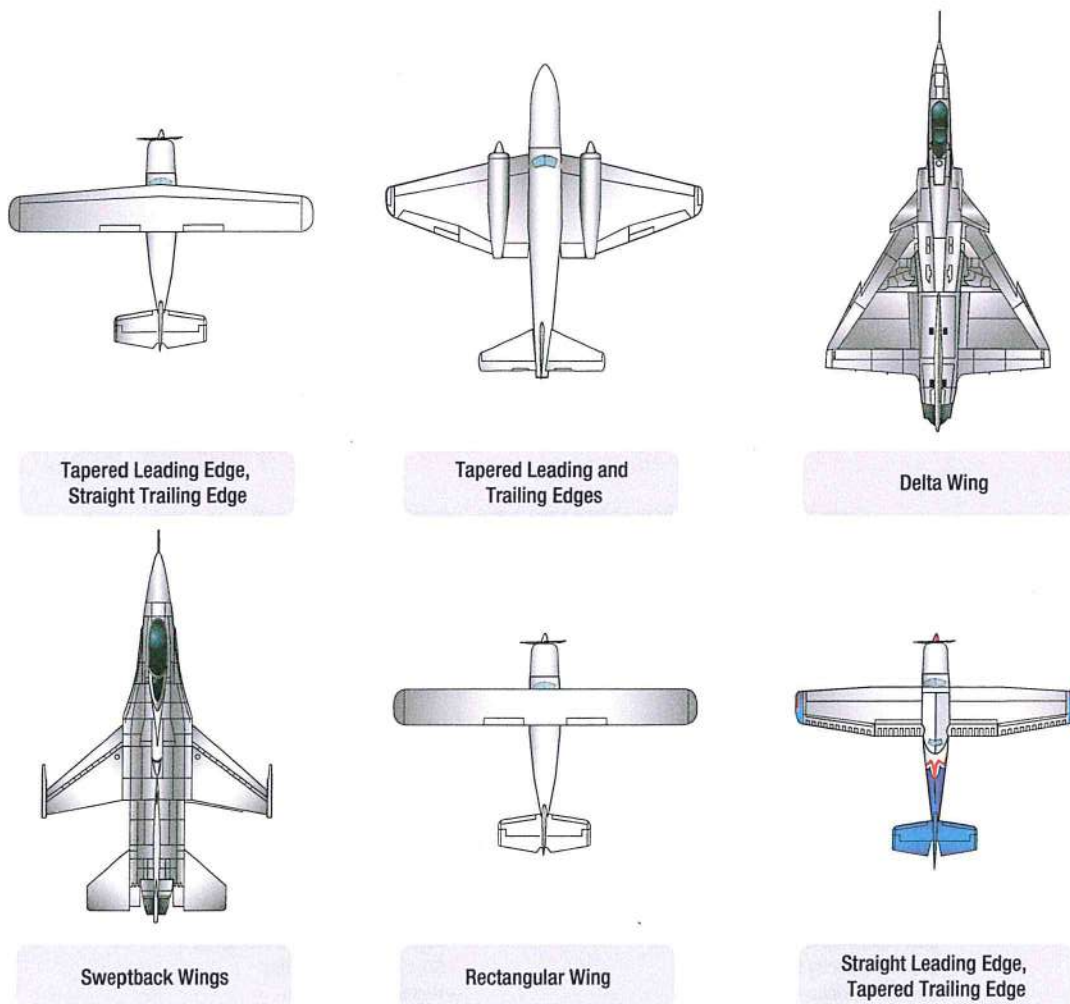

Figure 2-5. Various wing planforms.

PLANFORM AND VORTICES

The previous discussion of aerodynamic forces concerned the properties of airfoil sections in two-dimensional flow with no consideration given to the influence of the *planform*. The planform is the shape or outline of an aircraft wing as projected onto a horizontal plane. (Figure 2-5) When the effects of wing planform are introduced, attention must be directed to the existence of flow components in the span-wise direction. In other words, the airfoil section properties considered thus far deal with flow in two dimensions. Planform properties consider flow in three dimensions.

The pressure above the wing is less than atmospheric pressure, and the pressure below the wing is equal to or greater than atmospheric pressure. Since fluids always move from high pressure toward low pressure, in addition to the movement of air over the wing from front to rear, there is also a spanwise movement of air from the bottom of the wing outward from the fuselage and upward around the wing tip. This flow of air results in spillage over the wing tip, thereby setting up a whirlpool of air called a "vortex." (Figure 2-6) The plural of vortex is vortices.

As the difference in the pressure between the air on the bottom and top of the wing increases, more lift is generated. This increased pressure differential also causes more violent vortices. Small aircraft pilots must be especially vigilant when flying behind large aircraft. The vortices coming off the wingtips of a transport category aircraft could cause loss of control if encountered before they have had time to dissipate into the atmosphere.

Note that the air on the upper surface of the wing planform has a tendency to move in toward the fuselage and off the trailing edge as shown by the blue arrows in Figure 2-6.

This air current forms a similar vortex to a wingtip vortex but at the inner portion of the trailing edge of the wing. All vortices increase drag because of the turbulence produced, and constitute induced drag. Vortices increase as lift (and drag) increase. Drag will be discussed in further detail later in this module.

Just as lift increases by increasing of the angle of the airfoil into the wind, drag also increases as the angle becomes greater. This occurs because, within limits, as the angle is increased, the pressure difference between the top and bottom of the wing becomes greater. This causes more violent vortices to be set up, resulting in more turbulence and more induced drag.

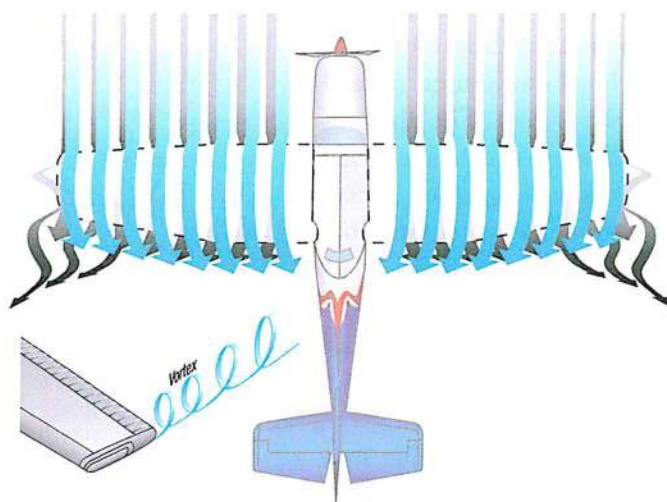

Figure 2-6. Wingtip vortices.

AERODYNAMIC TERMS

Before continuing the discussion on aerodynamics, some terms are defined and illustrations considered. The *chord* of a wing is the width of the wing from the leading edge apex to the trailing edge. A *chord line* is a line depicting the chord which extends forward of the leading edge. It is used for angular reference to the chord. (Figure 2-9) The average chord is the area of the

wing divided by the wing span. The *mean aerodynamic chord* is the average distance from the leading edge to the trailing edge of the wing. Due to the many wing planform designs, the mean aerodynamic chord is not necessarily half way from the fuselage to the wing tip as it is on a perfectly rectangular wing. However, the mean aerodynamic chord has half of the surface area

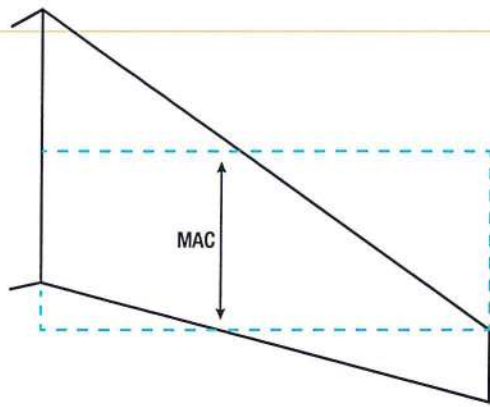

Figure 2-7. Mean aerodynamic chord (MAC).

of the wing on each side of it. (Figure 2-7) The mean aerodynamic chord is used by aerodynamicists when calculating stability and other design factors.

The acute angle the wing chord makes with the longitudinal axis of the aircraft is called the angle of incidence, or the angle of wing setting. (Figure 2-8)

The *angle of incidence* in most cases is a fixed, built-in angle. When the leading edge of the wing is higher than the trailing edge, the angle of incidence is said to be positive. The angle of incidence is negative when the leading edge is lower than the trailing edge of the wing.

Other unique features of wings include wash in and wash out. A wing does not have to be constructed flat in a single plain. A wing may be twisted from root to tip



Figure 2-8. Angle of incidence.

in order to provide better aerodynamic characteristics especially stall characteristics. When a wing is twisted down at the tip so that the angle of incidence is less at the wingtip than it is at the wing root, it is called washout. If the wing is twisted in the opposite direction so that the wing tip angle of incidence is greater than at the wing root, it's called wash in.

Refer to Figure 2-9 to clarify the following terms. The camber of a wing is the curve of the upper wing surface. The lower surface of the wing also has camber. The mean camber line lies within the wing half way between the upper camber and the lower camber. Maximum camber is located where the mean camber line is the greatest distance from the chord line.

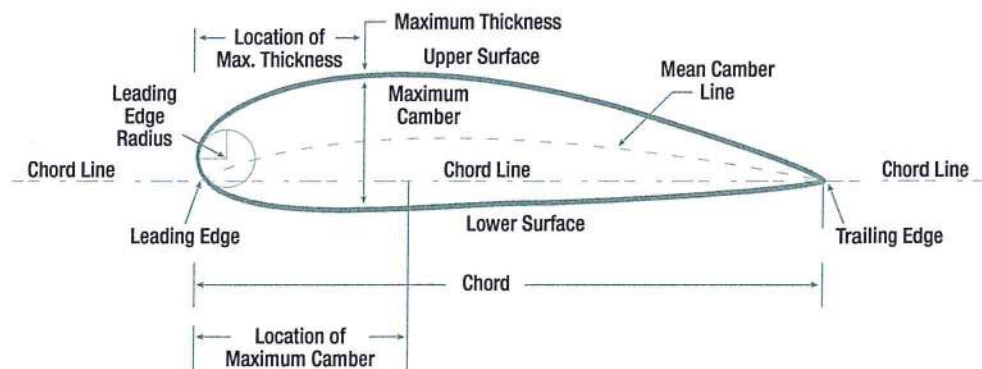

Figure 2-9. Chord and camber of a wing.

AIRFOILS

Since an *airfoil* is a surface designed to obtain lift from the air through which it moves, it can be stated that any part of the aircraft that converts air resistance into lift is an airfoil. The profile of a conventional wing is an excellent example of an airfoil. (Figure 2-10)

Notice that the top surface of the wing profile has greater curvature than the lower surface.

The difference in curvature of the upper and lower surfaces of the wing creates the lifting force. Air flowing over the top surface of the wing must reach the trailing edge of the wing in the same amount of time as the air flowing under the wing. To do this, the air passing over the top surface moves at a greater velocity than the air passing below the wing because of the greater distance it must travel along the top surface. This increased velocity, according to Bernoulli's Principle, means a corresponding decrease in pressure on the upper surface.

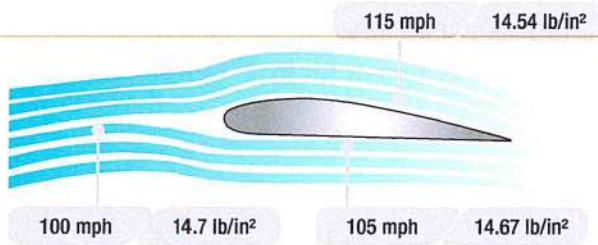

Figure 2-10. Airflow over a wing section.

Thus, a pressure differential is created between the upper and lower surfaces of the wing, forcing the wing upward in the direction of the lower pressure.

SHAPE OF THE AIRFOIL

Individual airfoil section properties differ from those properties of the entire wing or aircraft as a whole because of the effect of the wing planform. A wing may have various airfoil sections from root to tip, with taper, twist, and sweepback. The resulting aerodynamic properties of the wing are determined by the action of each section along the span.

The shape of the airfoil determines the amount of turbulence or skin friction that it produces, consequently affecting the efficiency of the wing. Turbulence and skin friction are controlled mainly by the *fineness ratio*, which is defined as the ratio of the chord of the airfoil to its maximum thickness. If the wing has a high fineness ratio, it is a very thin wing. A thick wing has a low fineness ratio. A wing with a high fineness ratio produces a large amount of skin friction. A wing with a low fineness ratio produces a large amount of turbulence. The best wing is a compromise between these two extremes to hold both turbulence and skin friction to a minimum.

Figure 2-11 illustrates a wide variety of airfoil shapes.

High-lift wings and high-lift devices for wings have been developed by shaping the airfoils to produce the desired effect. The amount of lift produced by an airfoil increases with an increase in wing camber. As stated, camber refers to the curvature of an airfoil surface above and below the chord line. Upper camber refers to the upper surface, lower camber to the lower surface, and mean camber to the mean line of the section. Camber is positive when departure from the chord line is outward and negative when it is inward. Thus, high-lift wings have a large positive camber on the upper surface and a slightly negative camber on the lower surface.

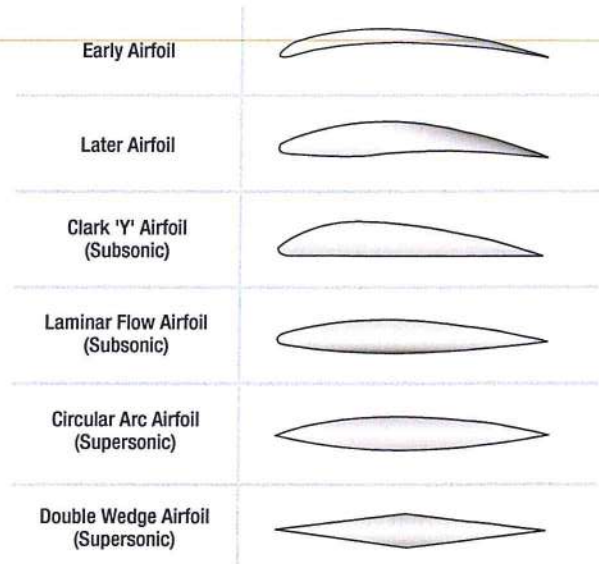

Figure 2-11. Airfoil designs.

Wing flaps cause an ordinary wing to approximate this same condition by increasing the upper camber and by creating a negative lower camber. It is also known that the larger the wingspan, as compared to the chord, the greater the lift obtained. This comparison is called *aspect ratio*. The higher the aspect ratio, the greater the lift. In spite of the benefits from an increase in aspect ratio, there are definite limitations defined by structural and drag considerations. On the other hand, an airfoil that is perfectly streamlined and offers little wind resistance sometimes does not have enough lifting power to take the aircraft off the ground. Thus, modern aircraft have airfoils which strike a medium between extremes, the shape depending on the purposes of the aircraft for which it is designed.

AIRFOIL CONTAMINATION

All discussion of aerodynamic behavior of airfoils assumes that the aircraft airfoils are free of contamination. Some of the most common forms of contamination are ice, snow and frost. Each of these, if accumulated on the aircraft, will reduce its capacity to develop lift. Ice commonly changes the shape of the airfoil which disrupts airflow and make it less efficient. Snow, ice, and especially frost, alter the smooth even surface that normally promotes laminar airflow. Laminar airflow is required to set up the pressure differential between the lower and upper wing surfaces that creates lift. All snow and ice must be completely removed from any aircraft before flight. Frost must also be removed. While it appears insignificant, the disruption to airflow caused by frost is possibly the most dangerous.

If ice is allowed to accumulate on the aircraft during flight (*Figure 2-12*), the weight of the aircraft is increased while the ability to generate lift is decreased. As little as

0.8 millimeter of ice on the upper wing surface increases drag and reduces aircraft lift by 25 percent.

THRUST, WEIGHT, LIFT AND DRAG

There are four forces that act upon an aircraft in flight: thrust, weight, lift and drag. A brief description of each is given. A discussion of angle of attack, lift and drag follows. Further exploration of the relationship between the four forces of flight occurs in *Sub-Module 03*.

1. *Thrust*—the force that moves the aircraft forward. Thrust is the forward force produced by the powerplant that overcomes the force of drag.
2. *Gravity or weight*—the force that pulls the aircraft toward the earth. Weight is the force of gravity acting downward upon everything that goes into the aircraft, such as the aircraft itself, crew, fuel, and cargo.

3. *Lift*—the force that pushes the aircraft upward. Lift acts vertically and counteracts the effects of weight.
4. *Drag*—the force that exerts a braking action to hold the aircraft back. Drag is a backward deterrent force and is caused by the disruption of the airflow by the wings, fuselage, and protruding objects.

Figure 2-13 illustrates the vectors of these four forces. They are in perfect balance only when the aircraft is in straight-and-level unaccelerated flight.

AERODYNAMIC RESULTANT

An aircraft in flight is continuously affected by thrust, weight, lift and drag. The directions in which the forces act is known. The magnitude of the forces can be calculated. When the forces are not in balance, a resultant or resulting force will exist. This is the combined force of all of the forces acting on the aircraft. In all types of flying, flight calculations are based on the magnitude and direction of the four forces.

The forces of lift and drag are the direct result of the relationship between the relative wind and the aircraft. The force of lift always acts perpendicular to the relative wind, and the force of drag always acts parallel to and in the same direction as the relative wind. These forces

are actually the components that produce a resultant lift force on the wing. (*Figure 2-14*)



Figure 2-12. In-flight ice formation adds weight, increases drag and reduces lift.

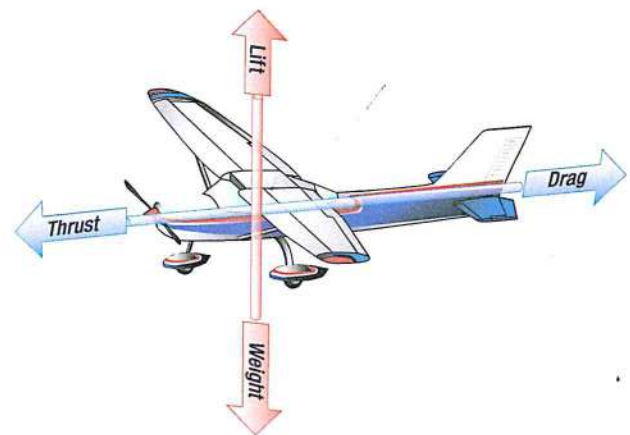

Figure 2-13. Forces in action during flight.

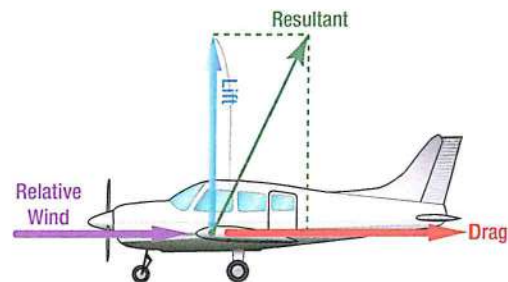

Figure 2-14. Resultant of lift and drag.

GENERATION OF LIFT AND DRAG

As stated, lift is the force that pushes the aircraft upwards. The *Angle of Attack (AOA)* is the angle between the relative wind and the chord line of the wing. Within limits, lift can be increased by increasing the angle of attack, wing area, velocity, density of the air, or by changing the shape or size of the airfoil. When the force of lift on an aircraft's wing equals the force of gravity, the aircraft maintains level flight.

Drag is the force that opposes the thrust created to move the aircraft forward. Induced drag is an inevitable

consequence of the creation of lift. It is caused by the downwash at the trailing edge of the wing meeting the air that flows underneath the wing and the general movement of the vortices created by this towards the wingtip where wingtip vortices are created. The greater the lift, the greater the pressure differential between these two flows of air which increases the induced drag. Since lift is able to be increased by increasing angle of attack, so too is induced drag. A discussion of the various types of drag and their production occurs after an examination of angle of attack.

LIFT AND DRAG COEFFICIENTS

Aerodynamicists calculate a Lift Coefficient (C_L) to model all of the complex variables that contribute to the generation of lift. It incorporates the shape and area of the airfoil, the angle of attack, and various flow conditions such as air density and velocity. In short, the *lift coefficient* is a ratio between lift pressure and dynamic pressure and is a function of the shape of the

wing and angle of attack. A Drag Coefficient (C_D) can also be calculated. Similarly, the drag coefficient incorporates the complex variables that contribute to the formation of drag. It is the ratio of drag pressure to dynamic pressure. The drag coefficient increases with the angle of attack and includes all types of drag as discussed in the section on drag below.

LIFT/DRAG RATIO

Drag is the price paid to obtain lift. The Lift to Drag ratio (L/D) is the amount of lift generated by a wing or airfoil compared to its drag. A ratio of L/D indicates airfoil efficiency. Aircraft with higher L/D ratios are more efficient than those with lower L/D

ratios. In unaccelerated flight with the lift and drag data steady, the proportions of the coefficient of lift (C_L) and Coefficient of Drag (C_D) can be calculated for specific AOA. (*Figure 2-15*)

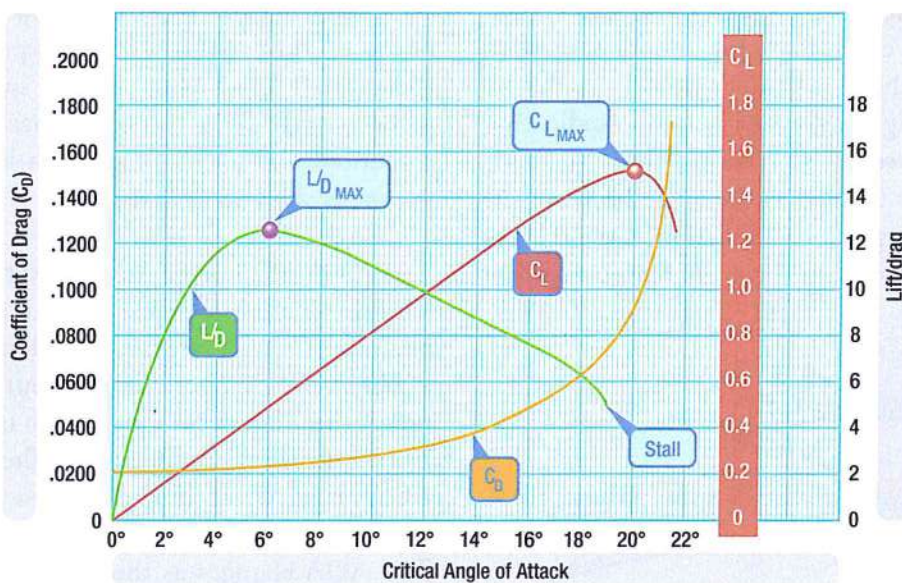

Figure 2-15. Lift Coefficients at various angles of attack.

The L/D ratio is determined by dividing the C_L by the C_D , which is the same as dividing the lift equation by the drag equation. All terms except coefficients cancel out.

L = Lift in pounds

D = Drag

Where L is the lift force in pounds, C_L is the lift coefficient, ρ is density expressed in slugs per cubic feet, V is velocity in feet per second, q is dynamic pressure per square feet, and S is the wing area in square feet.

C_D = Ratio of drag pressure to dynamic pressure. Typically at low angles of attack, the drag coefficient is low and small changes in angle of attack create only slight changes in the drag coefficient. At high angles of attack, small changes in the angle of attack cause significant changes in drag.

$$L = \frac{C_L \cdot \rho \cdot V^2 \cdot S}{2}$$

$$D = \frac{C_D \cdot \rho \cdot V^2 \cdot S}{2}$$

ANGLE OF ATTACK (AOA)

Before beginning the discussion on AOA and its effect on airfoils, first consider the terms chord and *Center of Pressure* (CP) as illustrated in *Figure 2-16*.

As stated, the chord of an airfoil or wing section is an imaginary straight line that passes through the section from the leading edge to the trailing edge, as shown in *Figure 2-16*. The chord line provides one side of an angle that ultimately forms the angle of attack. The other side of the angle is formed by a line indicating the direction of the relative airstream. Thus, the angle of attack or AOA is defined as the angle between the chord line of the wing and the direction of the relative wind. This is not to be confused with the angle of

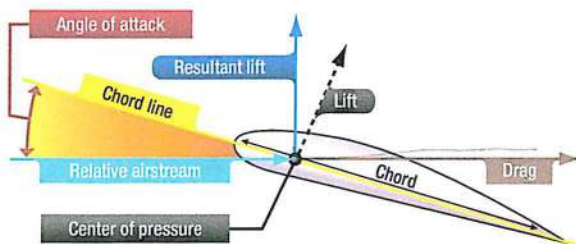

Figure 2-16. Airflow over a wing section.

The above formulas represent the Coefficient of Lift (C_L) and the Coefficient of Drag (C_D) respectively. The shape of an airfoil and other lift producing devices (e.g., flaps) effect the production of lift and alter with changes in the AOA. The lift/drag ratio is used to express the relation between lift and drag and is determined by dividing the lift coefficient by the drag coefficient, C_L/C_D .

Notice in *Figure 2-15* that the lift curve (red) reaches its maximum for this particular wing section at 20° AOA, and then rapidly decreases. 15° AOA is therefore the stalling angle. The drag curve (yellow) increases very rapidly from 14° AOA and completely overcomes the lift curve at 21° AOA. The lift/drag ratio (green) reaches its maximum at 6° AOA, meaning that at this angle, the most lift is obtained for the least amount of drag.

Note that the maximum Lift/Drag ratio (L/D_{MAX}) occurs at one specific C_L and AOA. If the aircraft is operated in steady flight at L/D_{MAX} , the total drag is at a minimum. Any AOA lower or higher than that for L/D_{MAX} reduces the L/D and consequently increases the total drag for a given aircraft's lift.

incidence that was illustrated in *Figure 2-8*, which is the angle between the chord line of the wing and the longitudinal axis of the aircraft.

On each part of an airfoil or wing surface, a small force is present. This force is of a different magnitude and direction from any forces acting on other areas forward or rearward from this point. It is possible to add all of these small forces. That sum is called the "resultant force" (lift). This resultant force has magnitude, direction, and location, and can be represented as a vector, as shown in *Figure 2-16*.

The point of intersection of the resultant force line with the chord line of the airfoil is called the center of pressure (CP). The CP moves along the airfoil chord as the AOA changes. Throughout most of the flight range, the CP moves forward with increasing AOA and rearward as the AOA decreases. The effect of increasing AOA on the CP is shown in *Figure 2-17*.

The AOA changes as the aircraft's attitude changes. Since the AOA has a great deal to do with determining

lift, it is given primary consideration when designing airfoils. In a properly designed airfoil, the lift increases as the AOA is increased.

When the AOA is increased gradually toward a positive AOA, the lift component increases rapidly up to a certain point and then suddenly begins to drop off. During this action the drag component increases slowly at first, then rapidly as lift begins to drop off. When the AOA increases to the angle of maximum lift, the *burble point* is reached. This is known as the *critical angle*. When the critical angle is reached, the air ceases to flow smoothly over the top surface of the airfoil and begins to burble or eddy. This means that air breaks away from the upper camber line of the wing. What was formerly the area of decreased pressure is now filled by this burbling air. When this occurs, the amount of lift drops and drag becomes excessive. The force of gravity exerts itself, and the nose of the aircraft drops. This is a *stall*. Thus, the burble point is the stalling angle.

As previously seen, the distribution of the pressure forces over the airfoil varies with the AOA. The application of the resultant force, or CP, varies correspondingly. As this angle increases, the CP moves forward; as the angle decreases, the CP moves back. The unstable travel of the CP is characteristic of almost all airfoils.

The efficiency of a wing is measured in terms of the lift to drag ratio (L/D). This ratio varies with the AOA but reaches a definite maximum value for a particular AOA. At this angle, the wing has reached its maximum efficiency. The shape of the airfoil is the factor that determines the AOA at which the wing is most efficient; it also determines the degree of efficiency. Research has shown that the most efficient airfoils for general use have the maximum thickness occurring about one-third of the way back from the leading edge of the wing.

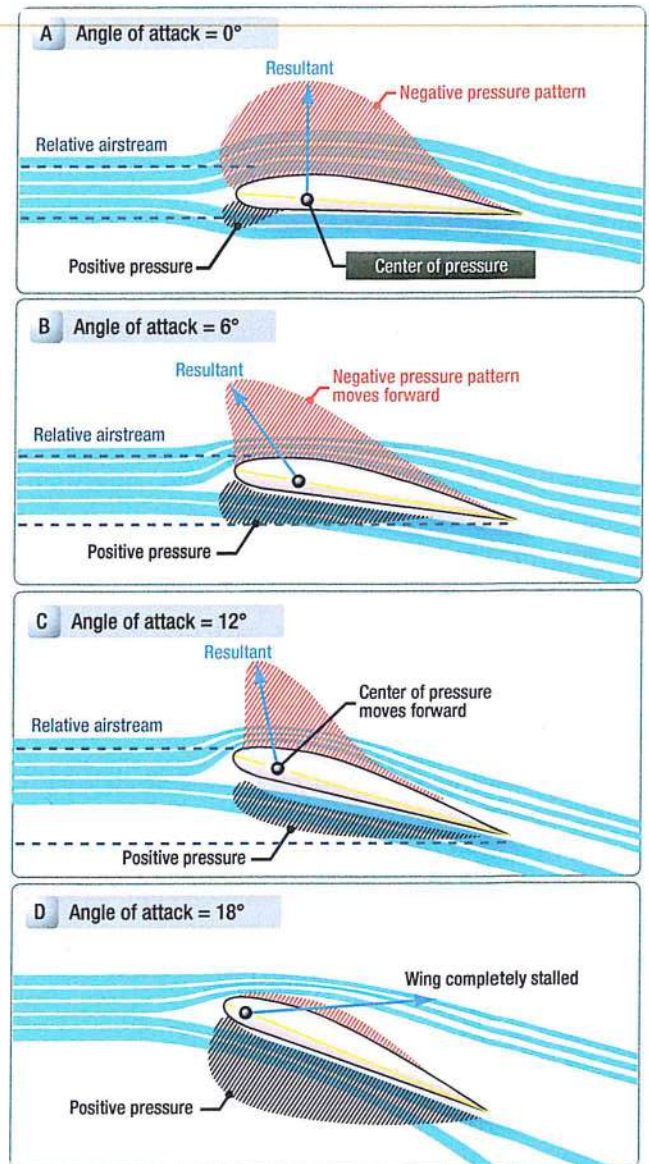

Figure 2-17. Effect on increasing angle of attack.

DRAG

There are many different types of drag. The most common are *parasite drag*, *induced drag* and *wave drag*.

Additionally, there are three types of parasite drag:

1. *Form drag* which results from the aerodynamic resistance to motion due to the shape of the aircraft.
2. *Skin friction drag* which is related to the smoothness (or roughness) of the aircraft surfaces.
3. *Interference drag* which occurs where surfaces with different flow characteristics meet (e.g. wing and fuselage). Briefly, induced drag is a secondary effect of the production of lift and wave drag comes into play when shock waves develop close to the surface of the aircraft during transonic or supersonic flight. In the following paragraphs, each of these types of drag will be explained in more detail.

PARASITE DRAG

Parasite (parasitic) Drag (DP) is defined as all drag that is not associated with the production of lift. Parasite drag is caused by moving a solid object through a fluid medium. In aerodynamics, the fluid medium concerned is the atmosphere. The principal components of parasite drag are form drag, friction drag and interference drag.

FORM DRAG

Form drag, also known as pressure drag or profile drag, is caused by the separation of the boundary layer from a surface and the wake created by that separation. It is primarily dependent upon the shape of the object.

The upper example in *Figure 2-18* shows the relative wind across a flat plate results in a leading edge stagnation point at the front of the plate that contains very high static pressure. The airflow attempts to maintain contact with the surface of the plate, but the streamlines are unable to follow the sharp angles which would be required to allow them to fill in behind the plate. As a result, they separate at the trailing edge of the plate leaving a low pressure wake area behind it. The pressure differential between the leading and trailing edges of the plate causes the plate to be pushed in the direction of the relative wind and retards forward motion. This is form drag.

To reduce form drag, aircraft surfaces which are exposed to the airflow of the relative wind are streamlined.

The remaining examples in *Figure 2-18* show how, as streamlining is increased, form drag is decreased.

FRICITION DRAG

Friction drag, also known as skin friction drag, is caused by the friction of a fluid against the surface of an object that is moving through it. It is directly proportional to the area of the surface in contact with the fluid and increases with the square of the velocity. In aerodynamics, the fluid concerned is the atmosphere.

Friction Drag is created in the boundary layer due to the viscosity of the air and the resulting friction against the surface of the aircraft. The air molecules in direct contact with the aircraft surface are most affected. As the molecules flow past the surface and past each other, the viscous resistance to that flow becomes a force which retards forward motion. The amount of friction drag that is created per square meter of surface area is relatively small. However, as the boundary layer covers much of the surface of the aircraft, friction drag can become quite significant in larger aircraft.

Turbulent flow creates more friction drag than laminar flow due to its greater interaction with the surface of the airplane. Rough surfaces accelerate the transition of boundary layer airflow from laminar to turbulent. This increases boundary layer thickness and the airflow

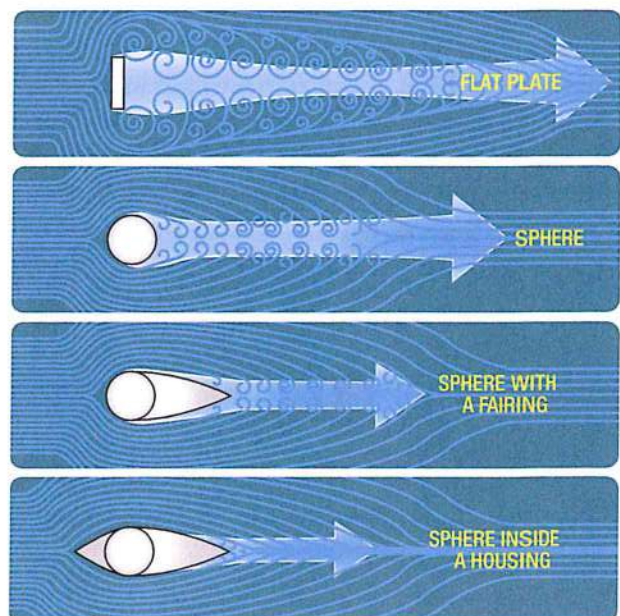

Figure 2-18. Form Drag.

disruption within the boundary layer. These increases result in more air molecules being affected by the movement of the aircraft and a corresponding increase in friction drag. Friction drag can be reduced by delaying the point at which laminar flow becomes turbulent. This can be accomplished by smoothing the exposed surfaces of the aircraft by using flush rivets on the leading edges and through painting, cleaning, waxing, polishing or the application of surface coatings.

INTERFERENCE DRAG

Interference drag is generated by the mixing of airflow streamlines between airframe components such as the wing and the fuselage, the engine pylon and the wing or, in the case of a military or other special purpose aircraft, between the airframe and attached external stores such as fuel tanks, weapons or sensor pods. (*Figure 2-19*)

Interference drag is generated when the airflow across one component of an aircraft is forced to mix with the airflow across an adjacent or proximal component. If one considers two parts of the aircraft that intersect at a particular point, such as the vertical and horizontal components of the empennage, it is obvious where the point of intersection occurs. Each of these two components generate high velocity (potentially transonic or even supersonic) airflow across their respective surfaces. At the intersection of the two surfaces, there is less physical space for the airflow to occupy resulting in the turbulent mixing of the two airflows and the production of a localized shock wave. Due to this shock wave, the resulting total drag from the empennage is greater than the sum of the drag produced individually by the vertical tail and the horizontal tail surfaces. Other significant locations which generate interference drag include the wing/fuselage junction and the wing/engine pylon or fuselage/engine pylon convergence.

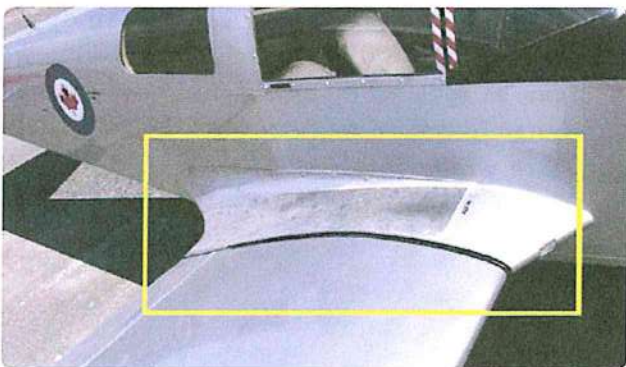

Figure 2-19. A wing root can cause interference drag.

As seen in *Figure 2-19*, interference drag can be minimized by the appropriate use of fairings and fillets to ease the transition between components. Fairings and fillets use curved surfaces to soften the transition at the junction of two aircraft components. This, in turn, allows the airflow streamlines to meet gradually rather than abruptly and reduces the amount of interference drag that is generated.

INDUCED DRAG

Induced Drag is an inevitable consequence of lift and is produced by the passage of an airfoil (e.g. wing or tailplane) through the air. Air flowing over the top of a wing tends to flow inwards because the decreased pressure over the top surface is less than the pressure outside the wing tip. Below the wing, the air flows outwards because the pressure below the wing is greater than that outside the wing tip. A direct consequence of this is that there is a continual spilling of air upwards around the wing tip phenomenon called ‘tip effect’ or ‘end effect’. One way to appreciate why a high aspect ratio for a wing is better than a low one is that with a high aspect ratio, the proportion of air which moves in this way is reduced and therefore more of it generates lift.

For the wing more generally, since the streams of air from above and below the wing which meet along the trailing edge are flowing at an angle to each other as they meet, they combine to form vortices, which, when viewed from the rear, rotate clockwise from the left wing and counter clockwise from the right. The tendency is for these vortices to move outwards towards the wing tip joining up as they do so. Eventually, by the time the wing tip is reached, one large wing tip vortex has formed and is shed.

Most of the air flowing off the top of a wing (downwash) continues more or less horizontally towards the empennage because it is balanced by a corresponding upwash in front of the wing leading edge. In contrast, the upwards air movement which leads to vortex consolidation at the tip is just outside the tip whereas the corresponding downward movement is just at the extremity of the wingspan so that the net direction of airflow past the wing is downwards. The lift created by the wing, which is by definition at right angles to the airflow, is therefore inclined slightly backwards and thus contributes to induced drag.

Although there must always be at least some induced drag because wings have a finite thickness, designers attempt wherever possible to reduce this flow. A required wing area can be achieved using different wing span-to-chord ratios (aspect ratios). The larger the wing aspect ratio, the less air disturbance is created at the tip. However, for most aircraft, there are both practical limits to maximum wing span for ground maneuvering and structural issues which mean that eventually, the weight penalty to adequately strengthen a long thin wing becomes excessive. The fact that aircraft carry most of their fuel in the wings is also a factor in wing design. Typical transport aircraft aspect ratios range between 6:1 and 10:1.



Figure 2-20. Winglets help reduce induced drag.

Other ways to reduce induced drag and tip vortex strength in a wing design are also based upon reducing the quantity air movement upwards at the wing tip by aiming to generate relatively more of the lift away from tips. Wing taper towards the tip assists this as does wing twist. The Boeing 767 is an example of a twisted wing. The inner wing is set at a higher angle of attack than the outer wing and thus generates proportionately more lift whereas the tip, at a very small angle of attack generates very little.

WAVE DRAG

Wave drag is a force, or drag that retards the forward movement of an airplane, in both supersonic and transonic flight, as a consequence of the formation of shock waves.

Wave drag is caused by the formation of shock waves around the aircraft in supersonic flight or around some surfaces of the aircraft while in transonic flight. In cruise, most civil jet aircraft fly in the Mach .75 to .85 speed range. Shock waves are typically associated with supersonic aircraft, however, they also form on an aircraft traveling at less than the speed of sound.

Winglets have also become popular, including both the usual up-turned versions and the Airbus 320 series two-way 'wingtip fence' versions. Well designed winglets can prevent about 20% of the airflow spillage at the tip, and therefore 20% of the induced drag. (Figure 2-20)

This occurs on the aircraft where local airflow is accelerated to sonic speed and then decreases back to subsonic speed. A shockwave (and associated wave drag) forms at the point the airflow becomes subsonic. This is common on aircraft airfoils. As the aircraft continues to accelerate, the area of the wing experiencing supersonic flow increases. The shockwave moves further back on the wing and becomes larger. Boundary layer separation also increases with the increase in speed and if the speed is allowed to increase beyond the limiting Mach number, severe buffeting, Mach tuck or "upset" (loss of control) may occur.

Induced drag and its wing tip vortices are a direct consequence of the creation of lift by the wing. Since the coefficient of lift is large when the angle of attack is large, induced drag is inversely proportional to the square of the speed whereas all other drag is directly proportional to the square of the speed. The effect of this is that induced drag is relatively unimportant at high speed in the cruise and descent where it probably represents less than 10% of total drag. In a climb, it is more important representing at least 20% of total drag. At slow speeds just after take off and in the initial climb, it is of maximum importance and may produce as much as 70% of total drag. Finally, when looking at the potential strength of wing tip vortices, theory on induced drag must be moderated by the effect of aircraft weight. Induced drag always increases with aircraft weight.

Shock waves radiate a considerable amount of energy, resulting in drag on the aircraft. This wave drag can be reduced by incorporating one or more aerodynamic design features such as wing sweep, ultra thin wings, fuselage shape, anti shock bodies and super critical airfoils.

DRAG AND AIRSPEED

Parasitic Drag increases with the square of the airspeed, while induced drag, being a function of lift, is greatest when maximum lift is being developed, usually at low speeds. *Figure 2-21* shows the relationship of parasitic drag and induced drag to each other and to total drag.

There is an airspeed at which drag is minimum, and in theory, this is the maximum range speed. However, flight at this speed is unstable because a small decrease in speed results in an increase in drag, and a further fall in speed. In practice, for stable flight, maximum range is achieved at a speed a little above the minimum drag speed where a small speed decrease results in a reduction in drag.

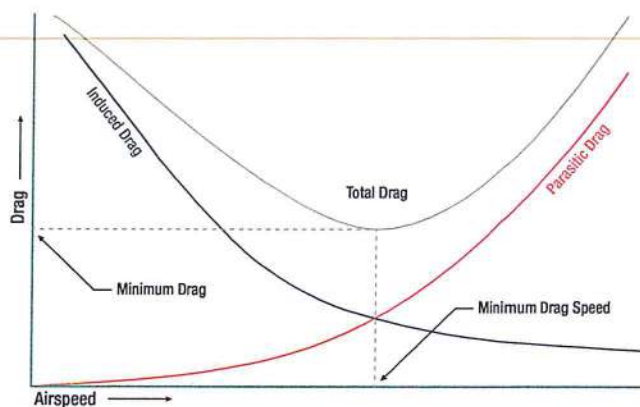

Figure 2-21. Different types of drag versus airspeed.

Question: 2-1

_____ is the rate of motion in a particular direction in relation to time.

Question: 2-5

A comparison between the wingspan and the chord of a wing is known as _____.

Question: 2-2

When fluid flowing through a tube reaches a constriction, the speed of the fluid _____ and the pressure of the fluid _____.

Question: 2-6

_____ is defined as the angle between the chord line of the wing and the direction of the relative wind.

Question: 2-3

The boundary layer is the part of the airflow that is _____ to the surface of the aircraft.

Question: 2-7

_____ drag is generated by the mixing of airflow streamlines between airframe components such as the wing and fuselage.

Question: 2-4

The _____ of a wing is the width of the wing from the leading edge apex to the trailing edge.

Question: 2-8

What type of drag continually increases as airspeed increases?

ANSWERS

Answer: 2-1
velocity.

Answer: 2-5
aspect ratio.

Answer: 2-2
increases.
decreases.

Answer: 2-6
Angle of Attack (AOA).

Answer: 2-3
closest.

Answer: 2-7
Interference.

Answer: 2-4
chord.

Answer: 2-8
Parasite Drag (DP).



BASIC AERODYNAMICS

THEORY OF FLIGHT

SUB-MODULE 03

PART-66 SYLLABUS CERTIFICATION CATEGORY →	LEVELS	
	B1	B2

Sub-Module 03
THEORY OF FLIGHT
 Knowledge Requirements

8.3 - Theory of Flight

Relationship between lift, weight, thrust and drag;
 Glide ratio;
 Steady state flights, performance;
 Theory of the turn;
 Influence of load factor: stall, flight envelope and structural limitations;
 Lift augmentation.

PART-66 SYLLABUS CERTIFICATION CATEGORY →	LEVELS	
	B1	B2
2	2	

THEORY OF FLIGHT

Level 2

A general knowledge of the theoretical and practical aspects of the subject and an ability to apply that knowledge.

Objectives:

- (a) The applicant should be able to understand the theoretical fundamentals of the subject.
- (b) The applicant should be able to give a general description of the subject using, as appropriate, typical examples.
- (c) The applicant should be able to use mathematical formula in conjunction with physical laws describing the subject.
- (d) The applicant should be able to read and understand sketches, drawings and schematics describing the subject.
- (e) The applicant should be able to apply his knowledge in a practical manner using detailed procedures.

RELATIONSHIP BETWEEN LIFT, WEIGHT, THRUST AND DRAG

WEIGHT, CENTER OF GRAVITY, LIFT

Gravity is the pulling force that tends to draw all bodies toward the center of the earth. The Center of Gravity (CG) may be considered as a point at which all the weight of the aircraft is concentrated. If the aircraft were supported at its exact CG, it would balance in any attitude. Note that the CG is of major importance in an aircraft, for its position has a great bearing upon stability.

The location of the CG is determined by the general design of each particular aircraft. The designers determine how far the Center of Pressure (CP) will travel. They then fix the CG forward of the center of pressure for the corresponding flight speed in order to provide an adequate restoring moment to retain flight equilibrium.

Weight has a definite relationship to lift. This relationship is simple, but important in understanding the aerodynamics of flying. Lift is the upward force on the wing acting perpendicular to the relative wind. Lift is required to counteract the aircraft's weight (which is caused by the force of gravity acting on the mass of the aircraft). This weight (gravity) force acts downward through the airplane's CG. In stabilized level flight, when the lift force is equal to the weight force, the aircraft is in a state of equilibrium and neither gains nor loses altitude. If lift becomes less than weight, the aircraft loses altitude. When lift is greater than weight, the aircraft gains altitude.

LIFT

The pilot can control lift. Any time the control yoke or stick is moved fore or aft, the Angle of Attack (AOA) is changed. As the AOA increases, lift increases (all other factors being equal). When the aircraft reaches the maximum AOA, lift begins to diminish rapidly. This is the stalling AOA, known as C_{L-MAX} critical AOA. Examine *Figure 2-15* in *Sub-Module 02* and note how the C_L increases until the critical AOA is reached, then decreases rapidly with any further increase in the AOA.

Before proceeding further with the topic of lift and how it can be controlled, velocity must be interjected. The shape of the wing (or rotor) cannot be effective unless it continually keeps "attacking" new air. If an aircraft is to keep flying, the lift-producing airfoil must keep moving.

In a helicopter or gyro-plane this is accomplished by the rotation of the rotor blades. For other types of aircraft such as airplanes, weight-shift control, or gliders, air must be moving across the lifting surface. This is accomplished by the forward speed of the aircraft. Lift is proportional to the square of the aircraft's velocity. For example, an airplane traveling at 200 knots has four times the lift as the same airplane traveling at 100 knots, if the AOA and other factors remain constant.

An aircraft cannot not continue to travel in level flight at a constant altitude and maintain the same AOA if the velocity is increased. The lift would increase and the aircraft would climb as a result of the increased lift force. Therefore, to maintain the lift and weight forces in balance, and to keep the aircraft straight and level (not accelerating upward) in a state of equilibrium, as velocity is increased, lift must be decreased. This is normally accomplished by reducing the AOA by lowering the nose. Conversely, as the aircraft is slowed, the decreasing velocity requires increasing the AOA to maintain lift sufficient to maintain flight. There is, of course, a limit to how far the AOA can be increased, if a stall is to be avoided.

All other factors being constant, for every AOA there is a corresponding airspeed required to maintain altitude in steady, unaccelerated flight (true only if maintaining "level flight"). Since an airfoil always stalls at the same AOA, when the weight of the aircraft is increased, lift must also be increased. The only method of increasing lift is by increasing velocity if the AOA is held constant just short of the "critical," or stalling, AOA.

Lift and drag also vary directly with the density of the air. Density is affected by several factors: pressure, temperature, and humidity. At an altitude of 18 000 feet, the density of the air has one-half the density of air at sea level. In order to maintain its lift at a higher altitude, an aircraft must fly at a greater true airspeed for any given AOA. Warm air is less dense than cool air, and moist air is less dense than dry air. Thus, on a hot humid day, an aircraft must be flown at a greater true airspeed for any given AOA than on a cool, dry day.

If the density factor is decreased and the total lift must equal the total weight to remain in flight, it follows that one of the other factors must be increased. The factor usually increased is the airspeed or the AOA, because these are controlled directly by the pilot.

Lift varies directly with the wing area, provided there is no change in the wing's planform. If the wings have the same proportion and airfoil sections, a wing with a planform area of 200 square feet lifts twice as much at the same AOA as a wing with an area of 100 square feet.

Two major aerodynamic factors from the pilot's viewpoint are lift and velocity because they can be controlled readily and accurately. Of course, the pilot can also control density by adjusting the altitude and can control wing area if the aircraft happens to have flaps of the type that enlarge wing area. However, for most situations, the pilot controls lift and velocity to maneuver an aircraft. For instance, in straight-and-level flight, cruising along at a constant altitude, altitude is maintained by adjusting lift to match the aircraft's velocity or cruise airspeed, while maintaining a state of equilibrium in which lift equals weight. In an approach to landing, when the pilot wishes to land as slowly as practical, it is necessary to increase lift to near maximum to maintain lift equal to the weight of the aircraft.

THRUST AND DRAG

Thrust has a definite relationship with drag. These relationships are quite simple, but very important in understanding the aerodynamics of flying.

Wing area is measured in square feet and includes the part blanked out by the fuselage. Wing area is adequately described as the area of the shadow cast by the wing at high noon. Tests show that lift and drag forces acting on a wing are roughly proportional to the wing area. This means that if the wing area is doubled,

all other variables remaining the same, the lift and drag created by the wing is doubled. If the area is tripled, lift and drag are tripled.

Drag must be overcome for the aircraft to move, and movement is essential to obtain lift. To overcome drag and move the aircraft forward, another force is essential. This force is thrust. Thrust is derived from jet propulsion or from a propeller and engine combination. Jet propulsion theory is based on Newton's third law of motion. The turbine engine causes a mass of air to be moved backward at high velocity causing a reaction that moves the aircraft forward.

In a propeller/engine combination, the propeller is actually two or more revolving airfoils mounted on a horizontal shaft. The motion of the blades through the air produces lift similar to the lift on the wing, but acts in a horizontal direction, pulling the aircraft forward.

Before the aircraft begins to move, thrust must be exerted. The aircraft continues to move and gain speed until thrust and drag are equal. In order to maintain a steady speed, thrust and drag must remain equal, just as lift and weight must be equal for steady, horizontal flight. If the revolutions per minute (rpm) of the engine is reduced, the thrust is lessened, and the aircraft slows down. As long as the thrust is less than the drag, the aircraft travels more and more slowly until its speed is insufficient to support it in the air. Likewise, if the rpm of the engine is increased, thrust becomes greater than drag, and the speed of the aircraft increases. As long as the thrust continues to be greater than the drag, the aircraft continues to accelerate. When drag equals thrust, the aircraft flies at a steady speed.

It is worth repeating that when lift balances weight and thrust balances drag, the aircraft is in level flight neither accelerating or slowing down.

GLIDE RATIO

The *glide ratio* of an airplane is the distance the airplane will, with power off, travel forward in relation to the altitude it loses. For instance, if an airplane travels 10 000 feet forward while descending 1 000 feet, its glide ratio is said to be 10 to 1.

The glide ratio is affected by all four fundamental forces that act on an airplane (weight, lift, drag, and thrust). If all factors affecting the airplane are constant, the glide ratio will be constant. Although the effect of wind will not be covered in this section, it is a very prominent force acting on the gliding distance of the airplane in relationship to its movement over the

ground. With a tailwind, the airplane will glide farther because of the higher groundspeed. Conversely, with a headwind the airplane will not glide as far because of the slower groundspeed.

Variations in weight do not affect the glide angle provided the pilot uses the correct airspeed. Since it is the Lift Over Drag (L/D) ratio that determines the distance the airplane can glide, weight will not affect the distance.

The glide ratio is based only on the relationship of the aerodynamic forces acting on the airplane. The only effect weight has is to vary the time the airplane will glide. The heavier the airplane the higher the airspeed must be to obtain the same glide ratio. For example, if two airplanes having the same L/D ratio, but different weights, start a glide from the same altitude, the heavier airplane gliding at a higher airspeed will arrive at the same touchdown point in a shorter time. Both airplanes will cover the same distance, only the lighter airplane will take a longer time.

Under various flight conditions, the drag factor may change through the operation of the landing gear and/or flaps. When the landing gear or the flaps are extended, drag increases and the airspeed will decrease unless the pitch attitude is lowered. As the pitch is lowered, the glidepath steepens and reduces the distance traveled. With the power off, a windmilling propeller also creates considerable drag, thereby retarding the airplane's forward movement.

Although the propeller thrust of the airplane is normally dependent on the power output of the engine, the throttle is in the closed position during a glide so the thrust is constant. Since power is not used during a

glide or power-off approach, the pitch attitude must be adjusted as necessary to maintain a constant airspeed.

The best speed for the glide is one at which the airplane will travel the greatest forward distance for a given loss of altitude in still air. This best glide speed corresponds to an angle of attack resulting in the least drag on the airplane and giving the best Lift-to-Drag ratio (L/D_{MAX}). (Figure 3-1)

Any change in the gliding airspeed will result in a proportionate change in glide ratio. Any speed, other than the best glide speed, results in more drag. Therefore, as the glide airspeed is reduced or increased from the optimum or best glide speed, the glide ratio is also changed. When descending at a speed below the best glide speed, induced drag increases. When descending at a speed above best glide speed, parasite drag increases. In either case, the rate of descent will increase. (Figure 3-2)

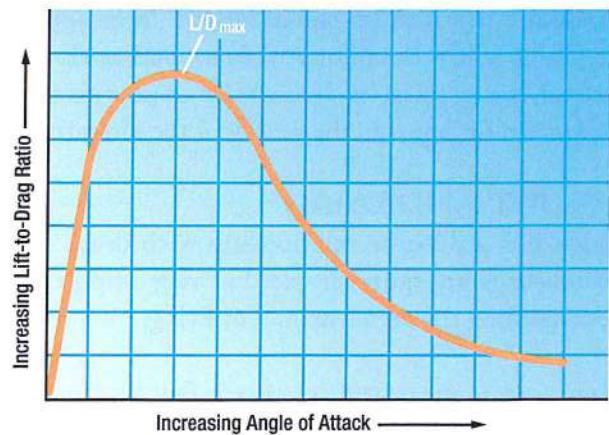

Figure 3-1. L/D_{MAX} .

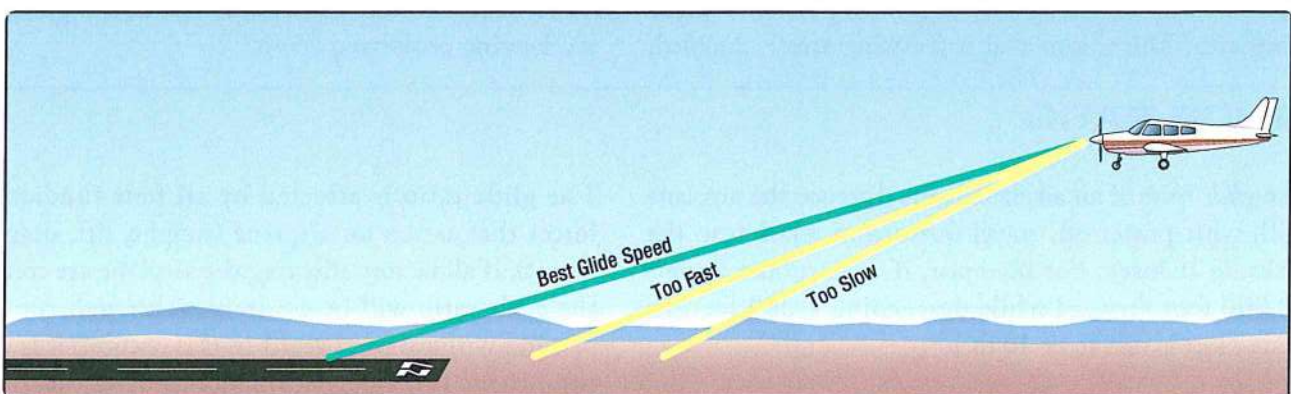

Figure 3-2. Best glide speed provides the greatest forward distance for a given loss of altitude.

The pilot must never attempt to "stretch" a glide by applying back-elevator pressure and reducing the airspeed below the airplane's recommended best glide

speed. Attempts to stretch a glide will invariably result in an increase in the rate and angle of descent and may precipitate an inadvertent stall.

POLAR CURVE

A *polar curve* is a graph which contrasts the sink rate of an aircraft with its horizontal speed. It is used mainly to illustrate performance of a glider.

Knowing the best speed to fly is important in exploiting the performance of a glider. Two of the key measures of a glider's performance are its minimum sink rate and its best *glide ratio*, also known as the best glide angle. These occur at different speeds. Knowing these speeds is important for efficient cross country flying. In still air the polar curve shows that flying at the minimum sink speed enables the pilot to stay airborne for as long as possible and to climb as quickly as possible. But at this speed, the glider will not travel as far as if it flew at the speed for the best glide. When in sinking air, the polar curve shows that best speed to fly depends on the rate that the air is descending. The optimal speed to fly for best cross country speed may often be considerably in excess of the speed for the best glide angle to get out of the sinking air as quickly as possible.

By measuring the rate of sink at various air-speeds a set of data can be accumulated and plotted on a graph. The points can be connected by a line known as the polar curve. Each type of glider has a unique polar curve. The

curve can be significantly degraded with debris such as bugs, dirt, and rain on the wing. Published polar curves will often be shown for a clean wing in addition to a dirty wing with bug splats represented by small pieces of tape applied to the leading edge of the wing.

The origin for a polar curve is where the air-speed is zero and the sink rate is zero. In *Figure 3-3* a line has been drawn from the origin to the point with minimum sink. The slope of the line from the origin gives the glide angle, because it is the ratio of the distance along the airspeed axis to the distance along the sink rate axis.

A whole series of lines could be drawn from the origin to each of the data points, each line showing the glide angle for that speed. However, the best glide angle is the line with the least slope. In *Figure 3-4*, the line has been drawn from the origin to the point representing the best glide ratio. The air-speed and sink rate at the best glide ratio can be read off the graph. Note that the best glide ratio is shallower than the glide ratio for minimum sink. All the other lines from the origin to the various data points would be steeper than the line of the best glide angle. Consequently, the line for the best glide angle will only just graze the polar curve, e.g. it is a tangent.

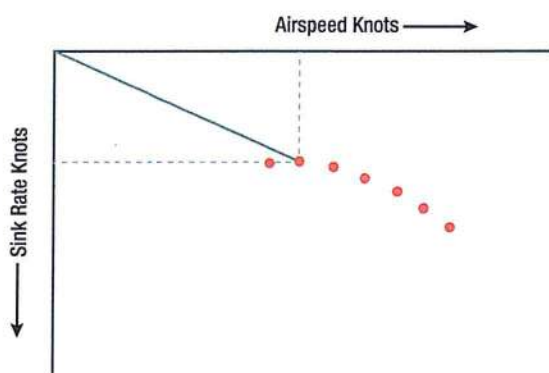

Figure 3-3. Polar curve showing glide angle for minimum sink.

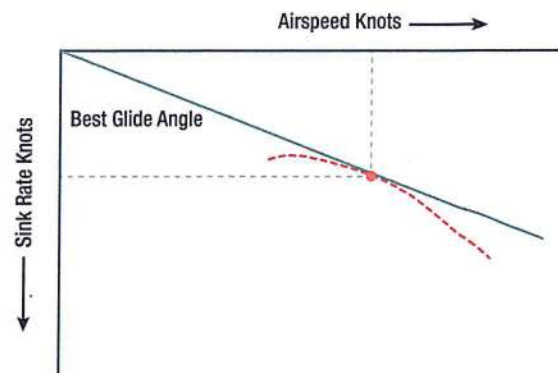

Figure 3-4. Polar curve showing glide angle for best glide.

AERODYNAMIC FORCES IN TURNS

If an aircraft were viewed in straight-and-level flight from the front (*Figure 3-5*), and if the forces acting

on the aircraft could be seen, lift and weight would be apparent: two forces. If the aircraft were in a bank it

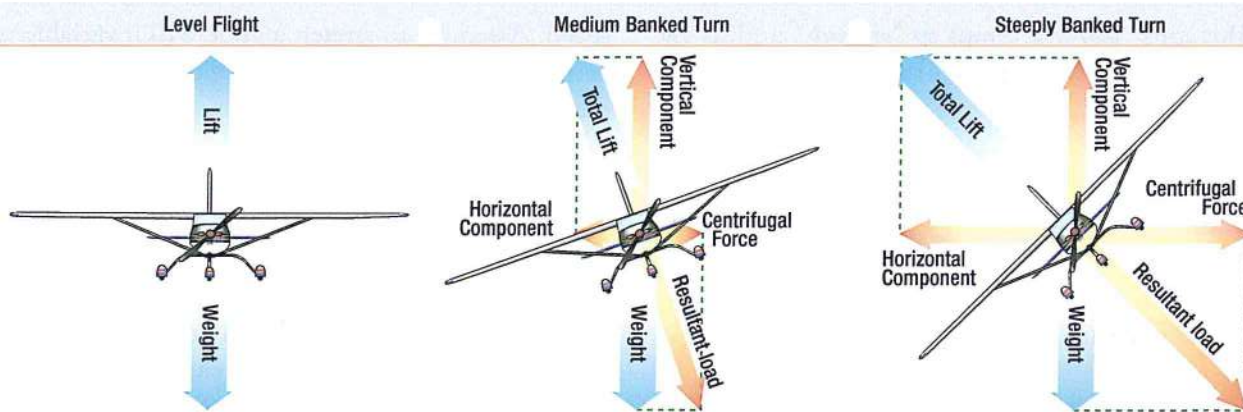

Figure 3-5. Forces during normal coordinated turns.

would be apparent that lift did not act directly opposite to the weight, rather it now acts in the direction of the bank. A basic truth about turns: when the aircraft banks, lift acts inward toward the center of the turn, as well as upward.

Newton's First Law of Motion, the Law of Inertia, states that an object at rest or moving in a straight line remains at rest or continues to move in a straight line until acted on by some other force. An aircraft, like any moving object, requires a sideward force to make it turn. In a normal turn, this force is supplied by banking the aircraft so that lift is exerted inward, as well as upward. The force of lift during a turn is separated into two components at right angles to each other. One component, which acts vertically and opposite to the weight (gravity), is called the "vertical component of lift." The other, which acts horizontally toward the center of the turn, is called the "horizontal component of lift," or centripetal force. The horizontal component of lift is the force that pulls the aircraft from a straight flightpath to make it turn.

Centrifugal force is the "equal and opposite reaction" of the aircraft to the change in direction and acts equal and opposite to the horizontal component of lift. This explains why, in a correctly executed turn, the force that turns the aircraft is not supplied by the rudder. The rudder is used to correct any deviation between the straight track of the nose and tail of the aircraft. A good turn is one in which the nose and tail of the aircraft track along the same path. If no rudder is used in a turn, the nose of the aircraft yaws to the outside of the turn. The rudder is used to bring the nose back in line with the relative wind.

An aircraft is not steered like a boat or an automobile. In order for an aircraft to turn, it must be banked. If it

is not banked, there is no force available to cause it to deviate from a straight flightpath. Conversely, when an aircraft is banked, it turns, provided it is not slipping to the inside of the turn.

Merely banking the aircraft into a turn produces no change in the total amount of lift developed. Since the lift during the bank is divided into vertical and horizontal components, the amount of lift opposing gravity and supporting the aircraft's weight is reduced. Consequently, the aircraft loses altitude unless additional lift is created. This is done by increasing the AOA until the vertical component of lift is again equal to the weight. Since the vertical component of lift decreases as the bank angle increases, the AOA must be progressively increased to produce sufficient vertical lift to support the aircraft's weight.

At a given airspeed, the rate at which an aircraft turns depends upon the magnitude of the horizontal component of lift. It is found that the horizontal component of lift is proportional to the angle of bank—that is, it increases or decreases respectively as the angle of bank increases or decreases. As the angle of bank is increased, the horizontal component of lift increases, thereby increasing the Rate of Turn (ROT). Consequently, at any given airspeed, ROT can be controlled by adjusting the angle of bank.

To provide a vertical component of lift sufficient to hold altitude in a level turn, an increase in the AOA is required. Since the drag of the airfoil is directly proportional to its AOA, induced drag increases as the lift is increased. This, in turn, causes a loss of airspeed in proportion to the angle of bank. A small angle of bank results in a small reduction in airspeed while a large

angle of bank results in a large reduction in airspeed. Additional thrust (power) must be applied to prevent a reduction in airspeed in level turns. The required amount of additional thrust is proportional to the angle of bank.

To compensate for added lift, which would result if the airspeed were increased during a turn, the AOA must be decreased, or the angle of bank increased, if a constant altitude is to be maintained. If the angle of bank is held constant and the AOA decreased, the ROT decreases. In order to maintain a constant ROT as the airspeed is increased, the AOA must remain constant and the angle of bank increased.

An increase in airspeed results in an increase of the turn radius, and centrifugal force is directly proportional to the radius of the turn. In a correctly executed turn, the horizontal component of lift must be exactly equal and opposite to the centrifugal force. As the airspeed is increased in a constant rate level turn, the radius of the turn increases. This increase in the radius of turn causes an increase in the centrifugal force, which must be balanced by an increase in the horizontal component of lift, which can only be increased by increasing the angle of bank.

In a slipping turn, the aircraft is not turning at the rate appropriate to the bank being used, since the aircraft is yawed toward the outside of the turning flightpath. The aircraft is banked too much for the ROT, so the horizontal lift component is greater than the centrifugal force. (Figure 3-6) Equilibrium between the horizontal lift component and centrifugal force is reestablished by either decreasing the bank, increasing the ROT, or a combination of the two changes.

A skidding turn results from an excess of centrifugal force over the horizontal lift component, pulling the aircraft toward the outside of the turn. The ROT is too great for the angle of bank. Correction of a skidding turn thus involves a reduction in the ROT, an increase in bank, or a combination of the two changes. To maintain a given ROT, the angle of bank must be varied with the airspeed. This becomes particularly important in high-speed aircraft. For instance, at 400 miles per hour (mph), an aircraft must be banked approximately 44° to execute a standard-rate turn (3° per second). At this angle of bank, only about 79 percent of the lift of the aircraft comprises the vertical component of the lift. This causes a loss of altitude unless the AOA is increased sufficiently to compensate for the loss of vertical lift.

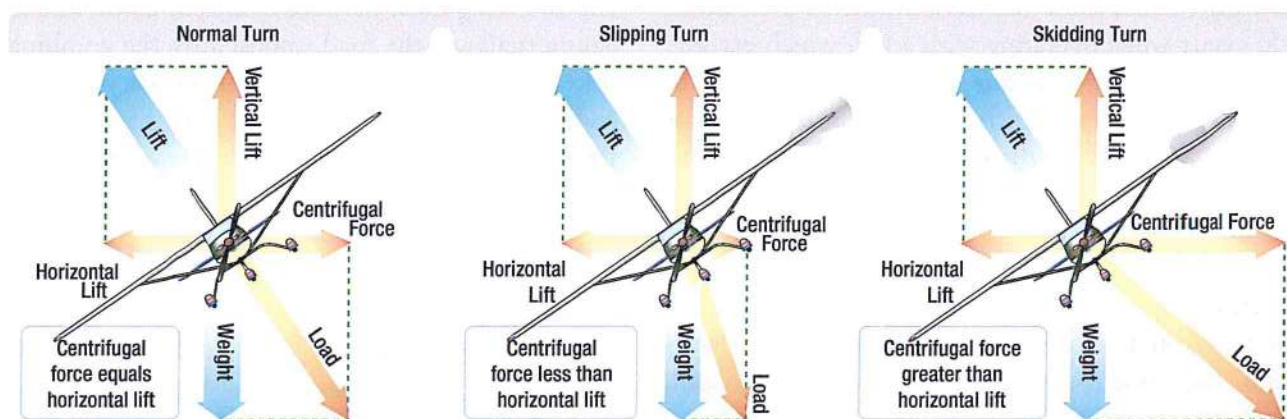

Figure 3-6. Normal, slipping, and skidding turns.

STALLS

An aircraft *stall* results from a rapid decrease in lift caused by the separation of airflow from the wing's surface brought on by exceeding the critical AOA. A stall can occur at any pitch attitude or airspeed. Stalls are one of the most misunderstood areas of aerodynamics because pilots often believe an airfoil stops producing lift

when it stalls. In a stall, the wing does not totally stop producing lift. Rather, it can not generate adequate lift to sustain level flight.

Since the C_L increases with an increase in AOA, at some point the C_L peaks and then begins to drop off.

This peak is called the C_{L-MAX} . The amount of lift the wing produces drops dramatically after exceeding the C_{L-MAX} or critical AOA, but as stated above, it does not completely stop producing lift.

In most straight-wing aircraft, the wing is designed to stall the wing root first. The wing root reaches its critical AOA first making the stall progress outward toward the wingtip. By having the wing root stall first, aileron effectiveness is maintained at the wingtips, maintaining controllability of the aircraft. Various design methods are used to achieve the stalling of the wing root first. In one design, the wing is "twisted" to a higher AOA at the wing root. Installing stall strips on the first 20–25 percent of the wing's leading edge is another method to introduce a stall prematurely.

The wing never completely stops producing lift in a stalled condition. If it did, the aircraft would fall to the Earth. Most training aircraft are designed for the nose of the aircraft to drop during a stall, reducing the AOA and "unstalling" the wing. The "nose-down" tendency is due to the CL being aft of the CG. The CG range is very important when it comes to stall recovery characteristics. If an aircraft is allowed to be operated outside of the CG, the pilot may have difficulty recovering from a stall. The most critical CG violation would occur when operating with a CG which exceeds the rear limit. In this situation, a pilot may not be able to generate sufficient force with the elevator to counteract the excess weight aft of the CG. Without the ability to decrease the AOA, the aircraft continues in a stalled condition until it contacts the ground.

The stalling speed of a particular aircraft is not a fixed value for all flight situations, but a given aircraft always stalls at the same AOA regardless of airspeed, weight, load factor, or density altitude. Each aircraft has a particular AOA where the airflow separates from the upper surface of the wing and the stall occurs. This critical AOA varies from 16° to 20° depending on the aircraft's design. But each aircraft has only one specific AOA where the stall occurs.

There are three flight situations in which the critical AOA can be exceeded: low speed, high speed, and turning. The aircraft can be stalled in straight-and-level flight by flying too slowly. As the airspeed decreases, the AOA must be increased to retain the lift required for

maintaining altitude. The lower the airspeed becomes, the more the AOA must be increased. Eventually, an AOA is reached which results in the wing not producing enough lift to support the aircraft which starts settling. If the airspeed is reduced further, the aircraft stalls, since the AOA has exceeded the critical angle and the airflow over the wing is disrupted.

Low speed is not necessary to produce a stall. The wing can be brought into an excessive AOA at any speed. For example, an aircraft is in a dive with an airspeed of 100 knots when the pilot pulls back sharply on the elevator control. (*Figure 3-7*)

Gravity and centrifugal force prevent an immediate alteration of the flightpath, but the aircraft's AOA changes abruptly from quite low to very high. Since the flightpath of the aircraft in relation to the oncoming air determines the direction of the relative wind, the AOA is suddenly increased, and the aircraft would reach the stalling angle at a speed much greater than the normal stall speed.

The stalling speed of an aircraft is also higher in a level turn than in straight-and-level flight. (*Figure 3-8*) Centrifugal force is added to the aircraft's weight and the wing must produce sufficient additional lift to counterbalance the load imposed by the combination of centrifugal force and weight. In a turn, the necessary additional lift is acquired by applying back pressure to the elevator control. This increases the wing's AOA, and results in increased lift. The AOA must increase as the

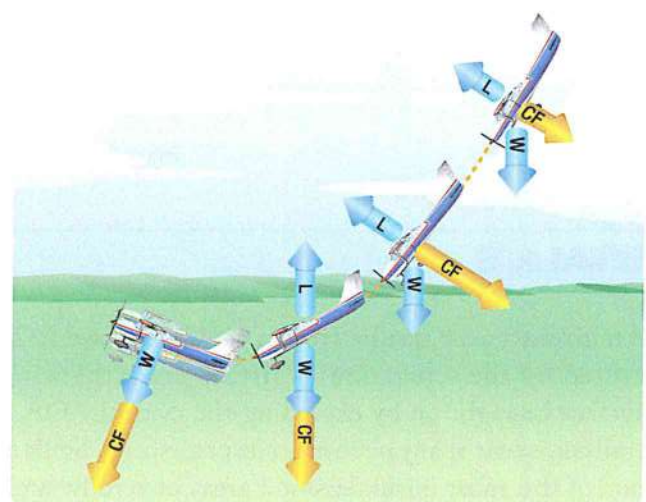

Figure 3-7. Forces exerted when pulling out of a dive.

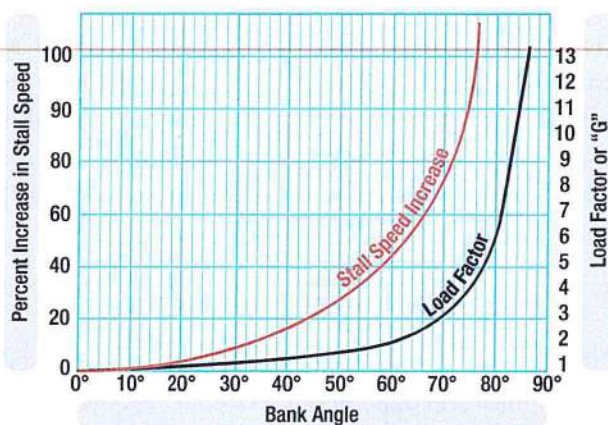

Figure 3-8. Increase in stall speed and load factor when banking.

bank angle increases to counteract the increasing load caused by centrifugal force. If at any time during a turn the AOA becomes excessive, the aircraft stalls.

At this point, the action of the aircraft during a stall should be examined. To balance the aircraft aerodynamically, the

CL is normally located aft of the CG. Although this makes the aircraft inherently nose-heavy, downwash on the horizontal stabilizer counteracts this condition. At the point of stall, when the upward force of the wing's lift and the downward tail force cease, an unbalanced condition exists. This allows the aircraft to pitch down abruptly, rotating about its CG. During this nose-down attitude, the AOA decreases and the airspeed again increases. The smooth flow of air over the wing begins again, lift returns, and the aircraft is again flying. Considerable altitude may be lost before this cycle is complete.

As stated in *Sub-Module 02*, airfoil shape and degradation of that shape must also be considered in a discussion of stalls. Combined with the increased drag and reduced lift generation due to the accumulation of ice, snow or frost on the aircraft lifting surfaces, a stall may occur at a lower angle of attack than normal or at a higher speed.

FLIGHT ENVELOPE AND STRUCTURAL LIMITATIONS

A flight envelope, performance envelope or service envelope refers to capabilities and limitations of a particular aircraft design package. In particular, performance airspeeds and load factors at different altitudes are considered. It is important to maintain flight "within the envelope" or a structural failure could occur.

LOAD FACTORS

In aerodynamics, *load factor* is the ratio of the maximum load an aircraft can sustain to the gross weight of the aircraft. The load factor is measured in Gs (acceleration of gravity), a unit of force equal to the force exerted by gravity on a body at rest and indicates the force to which a body is subjected when it is accelerated. Any force applied to an aircraft to deflect its flight from a straight line produces a stress on its structure, and the amount of this force is the load factor.

For example, a load factor of 3 means the total load on an aircraft's structure is three times its gross weight. Since load factors are expressed in terms of Gs, a load factor of 3 may be spoken of as 3 Gs, or a load factor of 4 as 4 Gs.

If an aircraft is pulled up from a dive, subjecting the pilot to 3 Gs, he or she would be pressed down into the seat with a force equal to three times his or her weight. Since modern aircraft operate at significantly higher speeds

than older aircraft, increasing the magnitude of the load factor, this effect has become a primary consideration in the design of the structure of all aircraft.

With the structural design of aircraft planned to withstand only a certain amount of overload, a knowledge of load factors has become essential for all pilots.

Load factors are important for two reasons:

1. It is possible for a pilot to impose a dangerous overload on the aircraft structures.
2. An increased load factor increases the stalling speed and makes stalls possible at seemingly safe flight speeds.

LOAD FACTORS IN AIRCRAFT DESIGN

The answer to the question "*How strong should an aircraft be?*" is determined largely by the use to which the aircraft is subjected. This is a difficult problem because the maximum possible loads are much too high for use in efficient design. It is true that any pilot can make a very hard landing or an extremely sharp pull up from a dive, which would result in abnormal loads. However, such extremely abnormal loads must be dismissed somewhat if aircraft are built that take off quickly, land slowly, and carry worthwhile payloads.

The problem of load factors in aircraft design becomes how to determine the highest load factors that can be expected in normal operation under various operational situations. These load factors are called "limit load factors." For reasons of safety, it is required that the aircraft be designed to withstand these load factors without any structural damage. Although certification requirements typically require the aircraft structure be capable of supporting one and one-half times these limit load factors without failure, it is accepted that parts of the aircraft may bend or twist under these loads and that some structural damage may occur.

This 1.5 load limit factor is called the "factor of safety" and provides, to some extent, for loads higher than those expected under normal and reasonable operation. This strength reserve is not something which pilots should willfully abuse; rather, it is there for protection when encountering unexpected conditions.

The above considerations apply to all loading conditions, whether they be due to gusts, maneuvers, or landings. The gust load factor requirements now in effect are substantially the same as those that have been in existence for years. Hundreds of thousands of operational hours have proven them adequate for safety. Since the pilot has little control over gust load factors (except to reduce the aircraft's speed when rough air is encountered), the gust loading requirements are substantially the same for most general aviation type aircraft regardless of their operational use. Generally, the gust load factors control the design of aircraft which are intended for strictly non-acrobatic usage.

An entirely different situation exists in aircraft design with maneuvering load factors. It is necessary to discuss this matter separately with respect to: (1) aircraft designed in accordance with the category system (e.g., normal, utility, acrobatic); and (2) older designs built according to requirements which did not provide for operational categories.

Aircraft designed under the category system are readily identified by a placard in the flight deck, which states the operational category (or categories) in which the aircraft is certificated. The maximum safe load factors (limit load factors) specified for aircraft in the various categories are:

Typical Category Limit Load Factors

Normal ¹	3.8 to -1.52
Utility (mild acrobatics, including spins)	4.4 to -1.76
Acrobatic	6.0 to -3.00

¹For aircraft with gross weight of more than 4 000 pounds, the limit load factor is reduced. To the limit loads given above, a safety factor of 50 percent is added. Also note that certification standards in various countries of manufacture may differ.

There is an upward graduation in load factor with the increasing severity of maneuvers. The category system provides for maximum utility of an aircraft. If normal operation alone is intended, the required load factor (and consequently the weight of the aircraft) is less than if the aircraft is to be employed in training or acrobatic maneuvers as they result in higher maneuvering loads.

Aircraft that do not have the category placard are designs that were constructed under earlier engineering requirements in which no operational restrictions were specifically given to the pilots. For aircraft of this type (up to weights of about 4 000 pounds), the required strength is comparable to present-day utility category aircraft, and the same types of operation are permissible. For aircraft of this type over 4 000 pounds, the load factors decrease with weight. These aircraft should be regarded as being comparable to the normal category aircraft designed under the category system, and they should be operated accordingly.

HIGH SPEED FLIGHT

SUBSONIC VS SUPERSONIC FLOW

In *subsonic* aerodynamics, the theory of lift is based upon the forces generated on a body and a moving gas (air) in which it is immersed. At speeds of approximately 260 knots, air can be considered incompressible in that,

at a fixed altitude, its density remains nearly constant while its pressure varies. Under this assumption, air acts the same as water and is classified as a fluid. Subsonic aerodynamic theory also assumes the effects of viscosity (the property of a fluid that tends to prevent motion

of one part of the fluid with respect to another) are negligible, and classifies air as an ideal fluid, conforming to the principles of ideal-fluid aerodynamics such as continuity, Bernoulli's principle, and circulation.

In reality, air is compressible and viscous. While the effects of these properties are negligible at low speeds, compressibility effects in particular become increasingly important as speed increases. Compressibility (and to a lesser extent viscosity) is of paramount importance at speeds approaching the speed of sound. In these speed ranges, compressibility causes a change in the density of the air around an aircraft.

During flight, a wing produces lift by accelerating the airflow over the upper surface. This accelerated air can, and does, reach sonic speeds even though the aircraft itself may be flying subsonic. At some extreme AOA, in some aircraft, the speed of the air over the top surface of the wing may be double the aircraft's speed. It is therefore entirely possible to have both *supersonic* and

subsonic airflow on an aircraft at the same time. When flow velocities reach sonic speeds at some location on an aircraft (such as the area of maximum camber on the wing), further acceleration results in the onset of compressibility effects such as shock wave formation, drag increase, buffeting, stability and control difficulties. Subsonic flow principles are invalid at all speeds above this point. (*Figure 3-9*)

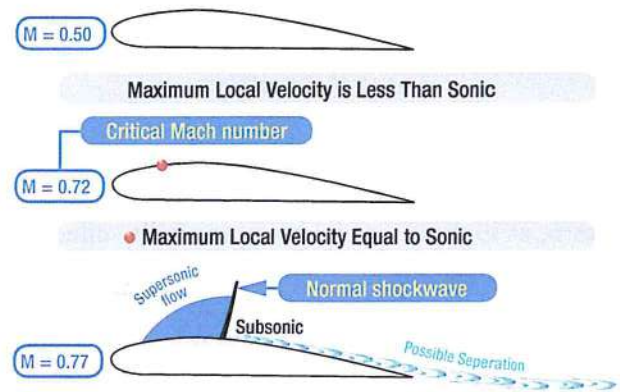

Figure 3-9. Wing Airflow.

SPEED RANGES

The speed of sound varies with temperature. Under standard temperature conditions of 15 °C, the speed of sound at sea level is 661 knots. At 40 000 feet, where the temperature is -55 °C, the speed of sound decreases to 574 knots. In high-speed flight and/or high-altitude flight, the measurement of speed is expressed in terms of a "Mach number"—the ratio of the true airspeed of the aircraft to the speed of sound in the same atmospheric conditions. An aircraft traveling at the speed of sound is traveling at Mach 1.0.

Aircraft speed regimes are defined approximately as follows:

- Subsonic—Mach numbers below 0.75
- Transonic—Mach numbers from 0.75 to 1.20
- Supersonic—Mach numbers from 1.20 to 5.00
- Hypersonic—Mach numbers above 5.00

While flights in the transonic and supersonic ranges are common occurrences for military aircraft, civilian jet aircraft normally operate in a cruise speed range of Mach 0.7 to Mach 0.90.

The speed of an aircraft in which airflow over any part of the aircraft or structure under consideration first reaches

(but does not exceed) Mach 1.0 is termed "critical Mach number" or "Mach Crit." Thus, critical Mach number is the boundary between subsonic and transonic flight and is largely dependent on the wing and airfoil design. Critical Mach number is an important point in transonic flight. When shock waves form on the aircraft, airflow separation followed by buffet and aircraft control difficulties can occur. Shock waves, buffet, and airflow separation take place above critical Mach number.

A jet aircraft typically is most efficient when cruising at or near its critical Mach number. At speeds 5–10 percent above the critical Mach number, compressibility effects begin. Drag begins to rise sharply. Associated with the "drag rise" are buffet, trim and stability changes, and a decrease in control surface effectiveness. This is the point of "drag divergence." (*Figure 3-10*)

VMO/MMO is defined as the maximum operating limit speed. VMO is expressed in Knots Calibrated Airspeed (KCAS), while MMO is expressed in Mach number. The VMO limit is usually associated with operations at lower altitudes and deals with structural loads and flutter. The MMO limit is associated with operations at higher altitudes and is usually more

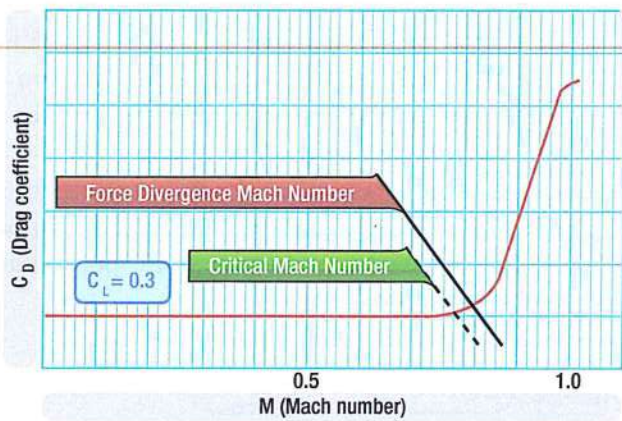

Figure 3-10. Critical Mach.

concerned with compressibility effects and flutter. At lower altitudes, structural loads and flutter are of concern; at higher altitudes, compressibility effects and flutter are of concern.

Adherence to these speeds prevents structural problems due to dynamic pressure or flutter, degradation in aircraft control response due to compressibility effects (e.g., Mach Tuck, aileron reversal, or buzz), and separated airflow due to shock waves resulting in loss of lift or vibration and buffet. Any of these phenomena could prevent the pilot from being able to adequately control the aircraft.

For example, an early civilian jet aircraft had a VMO limit of 306 KCAS up to approximately FL 310 (on a standard day). At this altitude (FL 310), an MMO of 0.82 was approximately equal to 306 KCAS. Above this altitude, an MMO of 0.82 always equaled a KCAS less than 306 KCAS and, thus became the operating limit as you could not reach the VMO limit without first reaching the MMO limit. For example, at FL 380, an MMO of 0.82 is equal to 261 KCAS.

MACH NUMBER VS AIRSPEED

It is important to understand how airspeed varies with Mach number. As an example, consider how the stall speed of a jet transport aircraft varies with an increase in altitude. The increase in altitude results in a corresponding drop in air density and outside temperature. Suppose this jet transport is in the clean configuration (gear and flaps up) and weighs 550 000 pounds. The aircraft might stall at approximately 152 KCAS at sea level. This is equal to (on a standard day) a true velocity of 152 KTAS and a Mach number of 0.23. At FL 380, the aircraft will still stall at approximately

152 KCAS but the true velocity is about 287 KTAS with a Mach number of 0.50.

Although the stalling speed has remained the same for our purposes, both the Mach number and TAS have increased. With increasing altitude, the air density has decreased; this requires a faster true airspeed in order to have the same pressure sensed by the pitot tube for the same KCAS or KIAS (for our purposes, KCAS and KIAS are relatively close to each other). The dynamic pressure the wing experiences at FL 380 at 287 KTAS is the same as at sea level at 152 KTAS. However, it is flying at higher Mach number.

Another factor to consider is the speed of sound. A decrease in temperature in a gas results in a decrease in the speed of sound. Thus, as the aircraft climbs in altitude with outside temperature dropping, the speed of sound is dropping. At sea level, the speed of sound is approximately 661 KCAS, while at FL 380 it is 574 KCAS. Thus, for our jet transport aircraft, the stall speed (in KTAS) has gone from 152 at sea level to 287 at FL 380. Simultaneously, the speed of sound (in KCAS) has decreased from 661 to 574 and the Mach number has increased from 0.23 (152 KTAS divided by 661 KTAS) to 0.50 (287 KTAS divided by 574 KTAS). All the while the KCAS for stall has remained constant at 152. This describes what happens when the aircraft is at a constant KCAS with increasing altitude, but what happens when the pilot keeps Mach constant during the climb? In normal jet flight operations, the climb is at 250 KIAS (or higher (e.g. heavy)) to 10 000 feet and then at a specified en route climb airspeed (such as about 330 if a DC10) until reaching an altitude in the "mid-twenties" where the pilot then climbs at a constant Mach number to cruise altitude.

Assuming for illustration purposes that the pilot climbs at a MMO of 0.82 from sea level up to FL 380. KCAS goes from 543 to 261. The KIAS at each altitude would follow the same behavior and just differ by a few knots. Recall from the earlier discussion that the speed of sound is decreasing with the drop in temperature as the aircraft climbs. The *Mach* number is simply the ratio of the true airspeed to the speed of sound at flight conditions. The significance of this is that at a constant Mach number climb, the KCAS (and KTAS or KIAS as well) is falling off.

If the aircraft climbed high enough at this constant MMO with decreasing KIAS, KCAS, and KTAS, it would begin to approach its stall speed. At some point the stall speed of the aircraft in Mach number could equal the MMO of the aircraft, and the pilot could neither slow up (without stalling) nor speed up (without exceeding the max operating speed of the aircraft). This has been dubbed the "coffin corner."

SHOCK WAVES

When an airplane flies at subsonic speeds, the air ahead is "warned" of the airplane's coming by a pressure change transmitted ahead of the airplane at the speed of sound. Because of this warning, the air begins to move aside before the airplane arrives and is prepared to let it pass easily. When the airplane's speed reaches the speed of sound, the pressure change can no longer warn the air ahead because the airplane is keeping up with its own pressure waves. Rather, the air particles pile up in front of the airplane causing a sharp decrease in the flow velocity directly in front of the airplane with a corresponding increase in air pressure and density.

As the airplane's speed increases beyond the speed of sound, the pressure and density of the compressed air ahead of it increase, the area of compression extending some distance ahead of the airplane. At some point in the airstream, the air particles are completely undisturbed, having had no advanced warning of the airplane's approach, and in the next instant the same air particles are forced to undergo sudden and drastic changes in temperature, pressure, density, and velocity.

The boundary between the undisturbed air and the region of compressed air is called a shock or "compression" wave. This same type of wave is formed whenever a supersonic airstream is slowed to subsonic without a change in direction, such as when the airstream is accelerated to sonic speed over the cambered portion of a wing, and then decelerated to subsonic speed as the area of maximum camber is passed. A *shock wave* forms as a boundary between the supersonic and subsonic ranges. Whenever a shock wave forms perpendicular to the airflow, it is termed a "normal" shock wave, and the flow immediately behind the wave is subsonic.

A supersonic airstream passing through a normal shock wave experiences these changes:

- The airstream is slowed to subsonic.
- The airflow immediately behind the shock wave does not change direction.
- The static pressure and density of the airstream behind the wave is greatly increased.
- The energy of the airstream (indicated by total pressure—dynamic plus static) is greatly reduced.

Shock wave formation causes an increase in drag. One of the principal effects of a shock wave is the formation of a dense high pressure region immediately behind the wave. The instability of the high pressure region, and the fact that part of the velocity energy of the airstream is converted to heat as it flows through the wave is a contributing factor in the drag increase, but the drag resulting from airflow separation is much greater. If the shock wave is strong, the boundary layer may not have sufficient kinetic energy to withstand airflow separation. The drag incurred in the transonic region due to shock wave formation and airflow separation is known as "*wave drag*." When speed exceeds the critical Mach number by about 10 percent, wave drag increases sharply. A considerable increase in thrust (power) is required to increase flight speed beyond this point into the supersonic range where, depending on the airfoil shape and the angle of attack, the boundary layer may reattach.

Normal shock waves form on the wing's upper surface and form an additional area of supersonic flow and a normal shock wave on the lower surface. As flight speed approaches the speed of sound, the areas of supersonic flow enlarge and the shock waves move nearer the trailing edge. (*Figure 3-11*)

Associated with "*drag rise*" are buffet (known as Mach buffet), trim and stability changes, and a decrease in control force effectiveness. The loss of lift due to airflow separation results in a loss of downwash, and a change in the position of the center pressure on the wing. Airflow separation produces a turbulent wake behind the wing, which causes the tail surfaces to buffet (vibrate). The nose-up and nose-down pitch control provided by the horizontal tail is dependent on the downwash behind the wing. Thus, an increase in downwash decreases the horizontal tail's pitch control effectiveness since it effectively increases the angle of attack that the tail surface is seeing.

Movement of the wing CP affects the wing pitching moment. If the CP moves aft, a diving moment referred to as "Mach tuck" or "tuck under" is produced, and if it moves forward, a nose-up moment is produced. This is the primary reason for the development of the T-tail configuration on many turbine-powered aircraft, which places the horizontal stabilizer as far as practical from the turbulence of the wings.

SWEEPBACK

Most of the difficulties of transonic flight are associated with shock wave induced flow separation. Therefore, any means of delaying or alleviating the shock induced separation improves aerodynamic performance. One method is wing sweepback. *Sweepback* theory is based upon the concept that it is only the component of the airflow perpendicular to the leading edge of the wing that affects pressure distribution and formation of shock waves. (Figure 3-12)

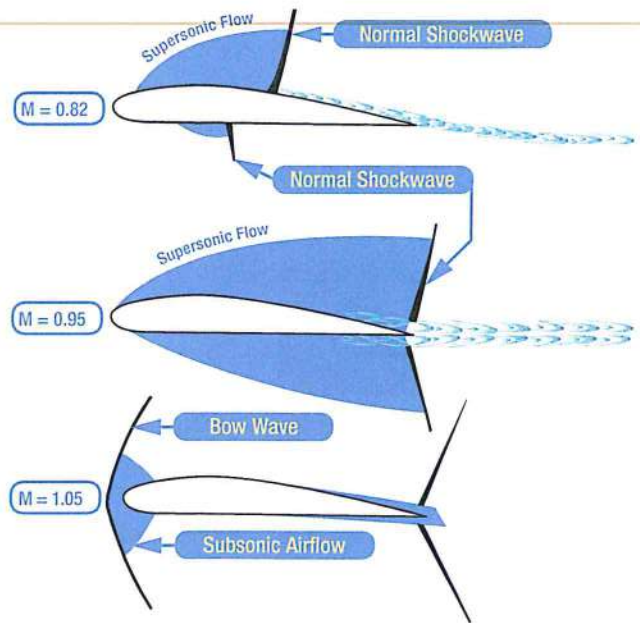

Figure 3-11. Shock waves.

On a straight wing aircraft, the airflow strikes the wing leading edge at 90°, and its full impact produces pressure and lift. A wing with sweepback is struck by the same airflow at an angle smaller than 90°. This airflow on the swept wing has the effect of persuading the wing into believing that it is flying slower than it really is; thus the formation of shock waves is delayed. Advantages of wing sweep include an increase in critical Mach number, force divergence Mach number, and the Mach number at which drag rises peaks. In other words, sweep delays the onset of compressibility effects.

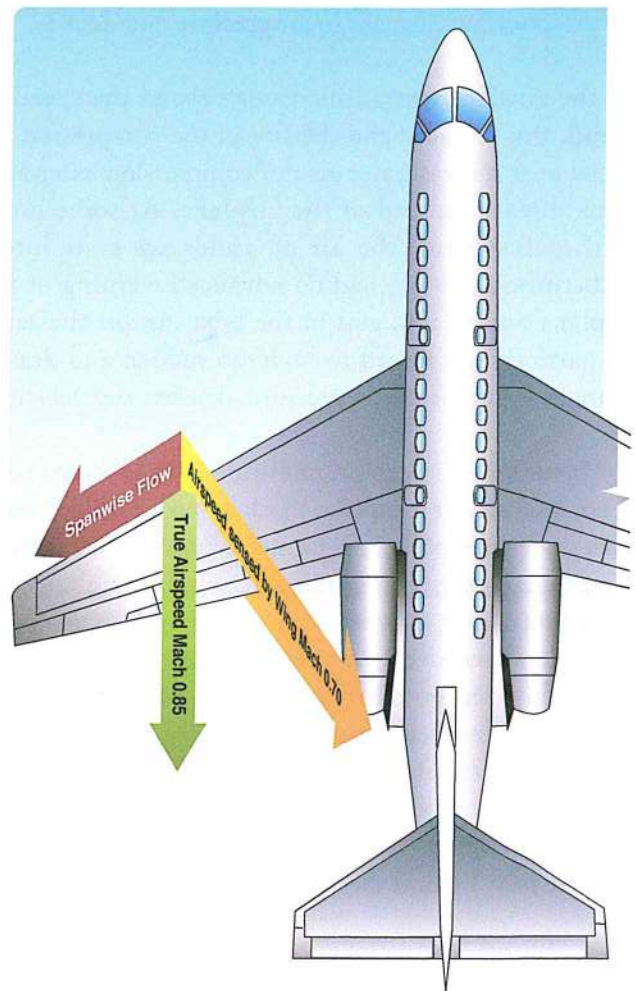

Figure 3-12. Sweepback effect.

The Mach number, which produces a sharp change in drag coefficient, is termed the "force divergence". Mach number for most airfoils, usually exceeds the critical Mach number by 5 to 10 percent. At this speed, the airflow separation induced by shock wave formation can create significant variations in the drag, lift, or pitching moment coefficients. In addition to the delay of the onset of compressibility effects, sweepback reduces the magnitude in the changes of drag, lift or moment coefficients. In other words, the use of sweepback "softens" the force divergence.

A disadvantage of swept wings is that they tend to stall at the wingtips rather than at the wing roots. (Figure 3-13) This is because the boundary layer tends to flow spanwise toward the tips and to separate near the leading edges. Because the tips of a swept wing are on the

aft part of the wing behind the center of lift (CL), a wingtip stall causes the center of lift to move forward on the wing, forcing the nose to rise further. The tendency for tip stall is greatest when wing sweep and taper are combined.

The stall situation can be aggravated by a T-tail configuration, which affords little or no pre-stall warning in the form of tail control surface buffet. (Figure 3-14)

The T-tail, being above the wing wake remains effective even after the wing has begun to stall, allowing the pilot to inadvertently drive the wing into a deeper stall at a much greater AOA. If the horizontal tail surfaces then become buried in the wing's wake, the elevator may lose all effectiveness, making it impossible to reduce pitch attitude and break the stall. In the pre-stall and immediate post-stall regimes, the lift/drag qualities of a swept wing aircraft (specifically the enormous increase in drag at low speeds) can cause an increasingly descending flightpath with no change in pitch attitude, further increasing the AOA. In this situation, without reliable AOA information, a nose-down pitch attitude with an increasing airspeed is no guarantee that recovery has been effected, and up-elevator movement at this stage may merely keep the aircraft stalled.

It is a characteristic of T-tail aircraft to pitch up viciously when stalled in extreme nose-high attitudes, making recovery difficult or violent. The stick pusher inhibits this type of stall. At approximately one knot above stall speed, pre-programmed stick forces automatically move the stick forward, preventing the stall from developing. A G-limiter may also be incorporated into the system to prevent the pitch down generated by the stick pusher from imposing excessive loads on the aircraft. A "stick shaker," on the other hand provides stall warning when the airspeed is five to seven percent above stall speed.

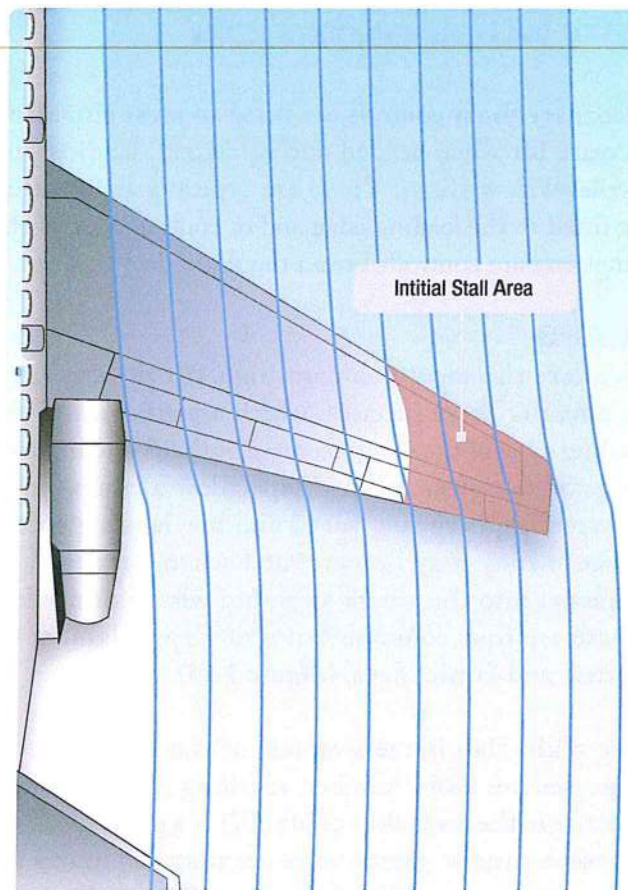

Figure 3-13. Wingtip stall.

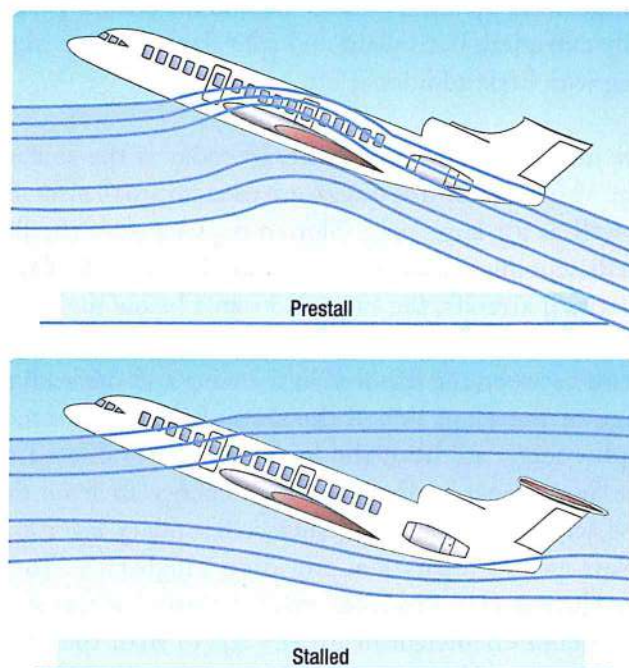

Figure 3-14. T-tail stall.

LIFT AUGMENTATION

Secondary flight controls are fitted to most aircraft to increase lift when needed during takeoff, landing and low-level slow flight. These are typically airfoils that are fitted to the leading edge and or trailing edge of the wings and are controlled from the flight deck.

FLAPS

Flaps are the most common high-lift devices used on aircraft. These surfaces, which are attached to the trailing edge of the wing, increase both lift and induced drag for any given AOA. Flaps allow a compromise between high cruising speed and low landing speed, because they may be extended when needed, and retracted into the wing's structure when not needed. There are four common types of flaps: plain, split, slotted, and Fowler flaps. (Figure 3-15)

The plain flap is the simplest of the four types. It increases the airfoil camber, resulting in a significant increase in the coefficient of lift (C_L) at a given AOA. At the same time, it greatly increases drag and moves the center of pressure (CP) aft on the airfoil, resulting in a nose-down pitching moment.

The split flap is deflected from the lower surface of the airfoil and produces a slightly greater increase in lift than the plain flap. More drag is created because of the turbulent air pattern produced behind the airfoil. When fully extended, both plain and split flaps produce high drag with little additional lift.

The most popular flap on aircraft today is the slotted flap. Variations of this design are used for small aircraft, as well as for large ones. Slotted flaps increase the lift coefficient significantly more than plain or split flaps. On small aircraft, the hinge is located below the lower surface of the flap, and when the flap is lowered, a duct forms between the flap well in the wing and the leading edge of the flap. When the slotted flap is lowered, high energy air from the lower surface is ducted to the flap's upper surface. The high energy air from the slot accelerates the upper surface boundary layer and delays airflow separation, providing a higher C_L . Thus, the slotted flap produces much greater increases in maximum coefficient of lift (C_{L-MAX}) than the plain or split flap. While there are many types of slotted flaps, large aircraft often have double and even triple-

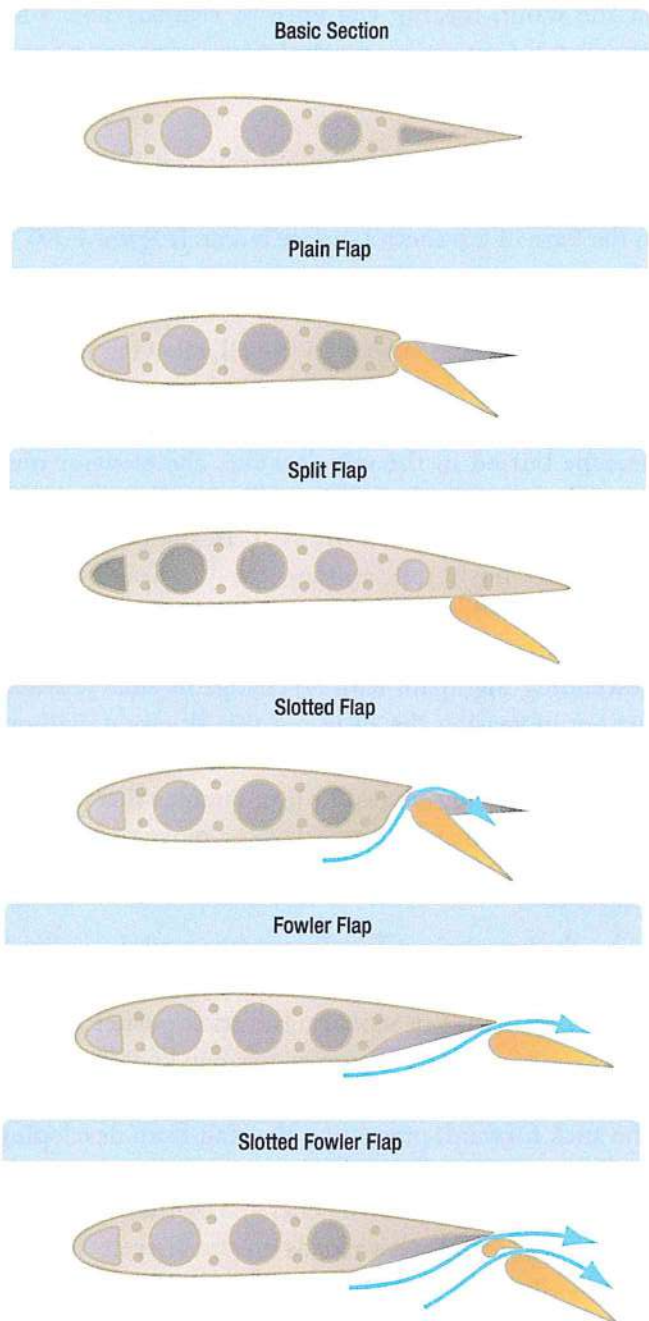

Figure 3-15. Four common types of flaps.

slotted flaps. These allow the maximum increase in drag without the airflow over the flaps separating and destroying the lift they produce.

Fowler flaps are a type of slotted flap. This flap design not only changes the camber of the wing, it also increases the wing area. Instead of rotating down on a hinge, it slides backwards on tracks. In the first portion of its extension, it increases the drag very little, but

increases the lift a great deal as it increases both the area and camber. As the extension continues, the flap deflects downward. During the last portion of its travel, the flap increases the drag with little additional increase in lift.

LEADING EDGE DEVICES

High-lift devices also can be applied to the leading edge of the airfoil. The most common types are fixed slots, movable slats, leading edge flaps, and cuffs. (Figure 3-16)

Fixed slots direct airflow to the upper wing surface and delay airflow separation at higher angles of attack. The slot does not increase the wing camber, but allows a higher maximum C_L because the stall is delayed until the wing reaches a greater AOA.

Movable slats consist of leading edge segments, which move on tracks. At low angles of attack, each slat is held flush against the wing's leading edge by the high pressure that forms at the wing's leading edge. As the AOA increases, the high-pressure area moves aft below the lower surface of the wing, allowing the slats to move forward. Some slats, however, are pilot operated and can be deployed at any AOA. Opening a slat allows the air below the wing to flow over the wing's upper surface, delaying airflow separation.

Leading edge flaps, like trailing edge flaps, are used to increase both C_{L-MAX} and the camber of the wings. This type of leading edge device is frequently used in conjunction with trailing edge flaps and can reduce the nose-down pitching movement produced by the latter. As is true with trailing edge flaps, a small increment of leading edge flaps increases lift to a much greater extent than drag. As greater amounts of flaps are extended, drag increases at a greater rate than lift.

Leading edge cuffs, like leading edge flaps and trailing edge flaps are used to increase both C_{L-MAX} and the camber of the wings. Unlike leading edge flaps and trailing edge flaps, leading edge cuffs are fixed aerodynamic devices. In most cases leading edge cuffs extend the leading edge down and forward. This causes the airflow to attach better to the upper surface of the wing at higher angles of attack, thus lowering an aircraft's stall speed. The fixed nature of leading edge cuffs extracts a penalty in maximum cruise airspeed, but recent advances in design and technology have reduced this penalty.

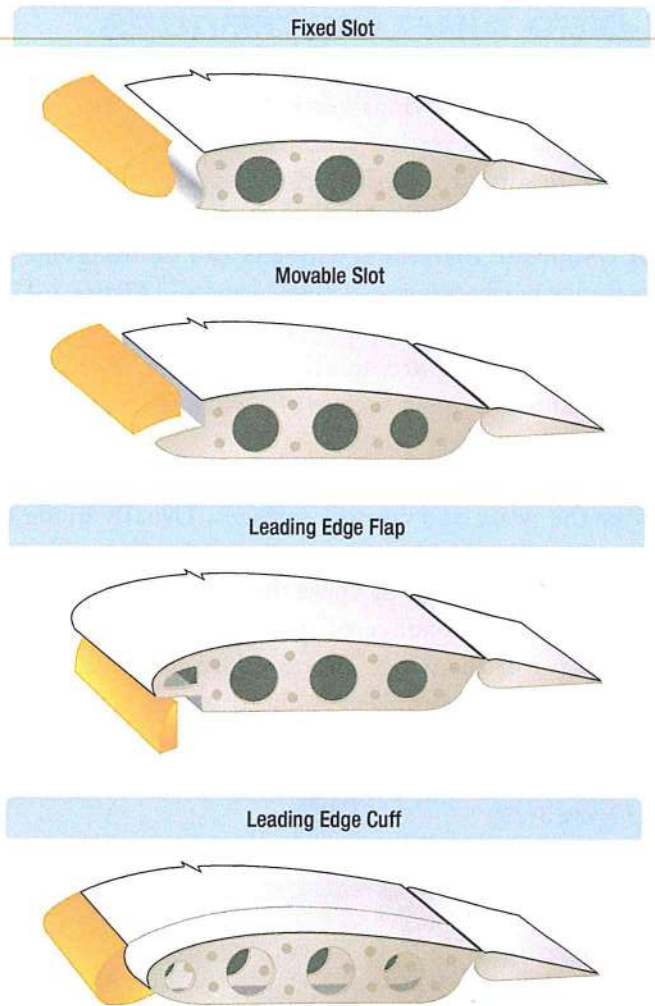

Figure 3-16. Leading edge high lift devices.



Figure 3-17. A winglet reduces induced drag caused by air spilling off of the wingtip.

FIXED AIRFLOW DEVICES

A *winglet* is an obvious vertical upturn of the wing's tip resembling a vertical stabilizer. It is an aerodynamic device designed to reduce the drag created by wing tip vortices in flight. Usually made from aluminum or composite materials, winglets can be designed to optimize performance at a desired speed. (Figure 3-17)

Vortex generators are small airfoil sections usually attached to the upper surface of a wing. (Figure 3-18)

They are designed to promote positive laminar airflow over the wing and control surfaces. Usually made of aluminum and installed in a span-wise line or lines, the vortices created by these devices swirl downward assisting maintenance of the boundary layer of air flowing over the wing. They can also be found on the fuselage and empennage. A chord-wise barrier on the upper surface of the wing, called a *stall fence*, sometimes called a *strake*, is used to halt the span-wise flow of air. (Figure 3-19)



Figure 3-18. Vortex generators.

During low speed flight, this can maintain proper chord-wise airflow reducing the tendency for the wing to stall. Usually made of aluminum, the fence is a fixed structure most common on swept wings, which have a natural span-wise tending boundary air flow.

Often, a gap can exist between the stationary trailing edge of a wing or stabilizer and the movable control surface(s). At high angles of attack, high pressure air from the lower wing surface can be disrupted at this gap. The result can be turbulent airflow, which increases drag. There is also a tendency for some lower wing boundary air to enter the gap and disrupt the upper wing surface airflow, which in turn reduces lift and control surface responsiveness. The use of gap seals is common to promote smooth airflow in these gap areas. Gap seals can be made of a wide variety of materials ranging from aluminum and impregnated fabric to foam and plastic. Figure 3-20 shows some gap seals installed on various aircraft.

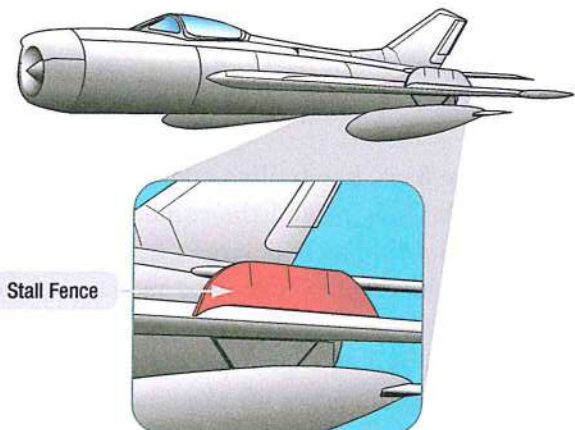

Figure 3-19. A stall fence halts the flow of span-wise air.



Figure 3-20. Gap seals promote the smooth flow of air over gaps between fixed and movable surfaces.

Question: 3-1

_____ is the upward force on the wing acting perpendicular to the relative wind.

Question: 3-5

The ratio of true airspeed to the speed of sound is known as _____.

Question: 3-2

To overcome _____ and move the aircraft forward, thrust is needed.

Question: 3-6

The effect of a sweptback wing is a delay in the onset of _____ effects.

Question: 3-3

An object at rest or moving in a straight line remains at rest or continues to move in a straight line until _____.

Question: 3-7

The most common high-lift device fitted to the aft edge of the wing which increases lift and drag is known as a _____.

Question: 3-4

The ratio of the maximum load an aircraft can sustain to the gross weight of the aircraft is called _____.

Question: 3-8

A _____ is a small airfoil section attached to the upper surface of a wing that promotes positive laminar airflow over the wing and control surfaces.

ANSWERS

Answer: 3-1
lift.

Answer: 3-5
mach number.

Answer: 3-2
drag.

Answer: 3-6
compressibility.

Answer: 3-3
acted on by some other force.

Answer: 3-7
flap.

Answer: 3-4
load factor.

Answer: 3-8
vortex generator.



BASIC AERODYNAMICS

FLIGHT STABILITY AND DYNAMICS

SUB-MODULE 04

PART-66 SYLLABUS LEVELS
CERTIFICATION CATEGORY → B1 B2

Sub-Module 04
FLIGHT STABILITY AND DYNAMICS
Knowledge Requirements

8.4 - Flight Stability and Dynamics

Longitudinal, lateral and directional stability (active and passive).

2 2

FLIGHT STABILITY AND DYNAMICS

Level 2

A general knowledge of the theoretical and practical aspects of the subject and an ability to apply that knowledge.

Objectives:

- (a) The applicant should be able to understand the theoretical fundamentals of the subject.
- (b) The applicant should be able to give a general description of the subject using, as appropriate, typical examples.
- (c) The applicant should be able to use mathematical formula in conjunction with physical laws describing the subject.
- (d) The applicant should be able to read and understand sketches, drawings and schematics describing the subject.
- (e) The applicant should be able to apply his knowledge in a practical manner using detailed procedures.

THE AXES OF AN AIRCRAFT

Whenever an aircraft changes its attitude in flight, it must turn about one or more of three axes. *Figure 4-1* shows the three axes, which are imaginary lines passing through the center of the aircraft.

The *axes* of an aircraft can be considered as imaginary axes around which the aircraft turns like a wheel. At the center, where all three axes intersect, each is perpendicular to the other two. The axis that extends lengthwise through the fuselage from the nose to the

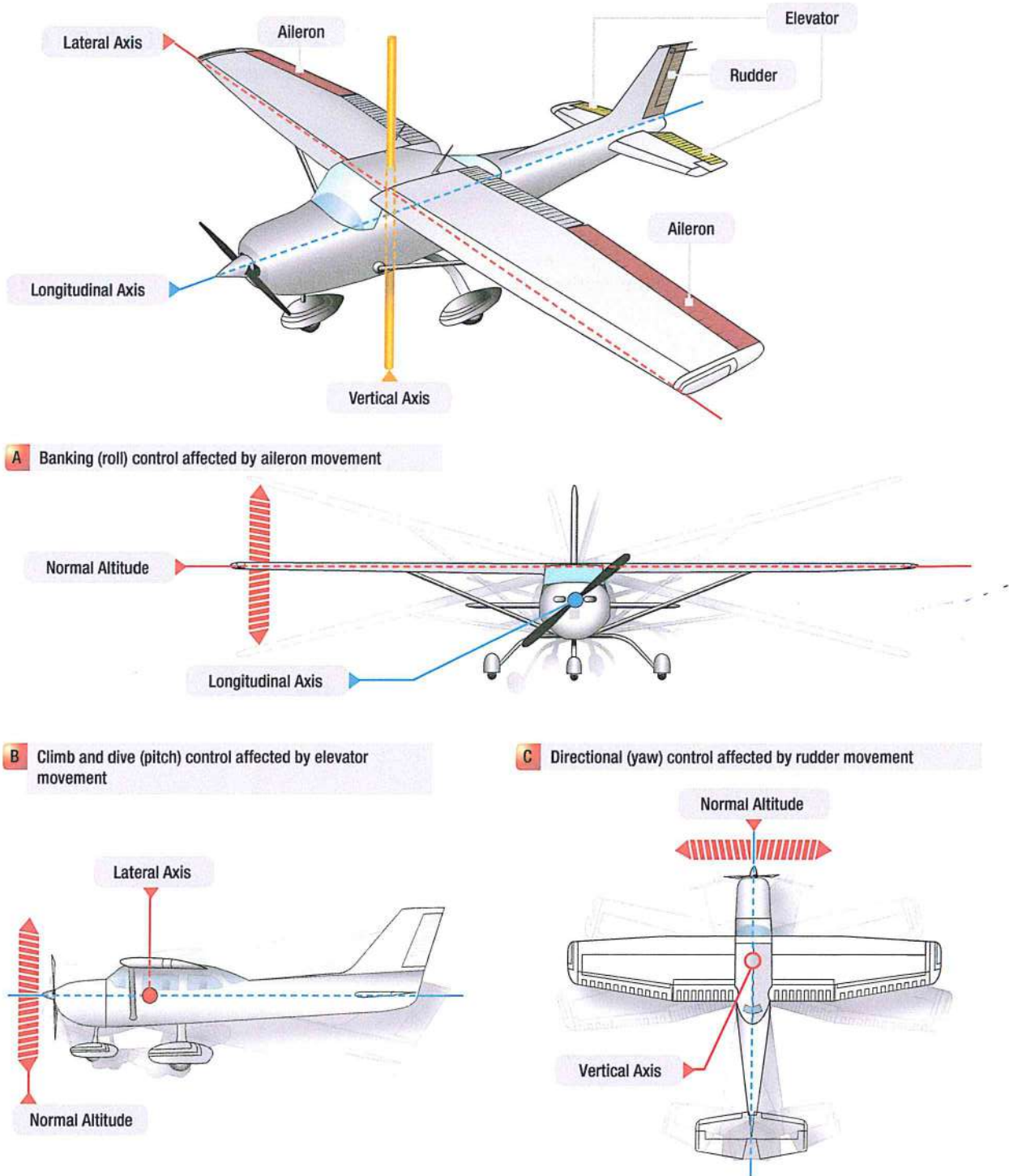

Figure 4-1. Motion of an aircraft about its axes.

tail is called the longitudinal axis. The axis that extends crosswise from wing tip to wing tip is the lateral, or pitch, axis. The axis that passes through the center, from top to bottom, is called the vertical, or yaw, axis. Roll, pitch, and yaw are controlled by three control surfaces.

Roll is produced by the ailerons, which are located at the trailing edges of the wings. Pitch is affected by the elevators, the rear portion of the horizontal tail assembly. Yaw is controlled by the rudder, the rear portion of the vertical tail assembly.

STABILITY AND CONTROL

An aircraft must have sufficient stability to maintain a uniform flightpath and recover from the various upsetting forces. Also, to achieve the best performance, the aircraft must have the proper response to the movement of the controls. Control is the pilot action of moving the flight controls, providing the aerodynamic force that induces the aircraft to follow a desired flightpath. When an aircraft is said to be controllable, it means that the aircraft responds easily and promptly to movement of the controls. Different control surfaces are used to control the aircraft about each of the three axes. Moving the control surfaces on an aircraft changes the airflow over the aircraft's surface. This, in turn, creates changes in the balance of forces acting to keep the aircraft flying straight and level.

Three terms that appear in any discussion of stability and control are: stability, maneuverability, and controllability. Stability is the characteristic of an aircraft that tends to cause it to fly (hands off) in a straight-and-level flightpath. Maneuverability is the characteristic of an aircraft to be directed along a desired flightpath and to withstand the stresses imposed. Controllability is

the quality of the response of an aircraft to the pilot's commands while maneuvering the aircraft. There are two kinds of stability, static and dynamic.

STATIC STABILITY

Static stability refers to the initial tendency, or direction of movement, back to equilibrium. In aviation, it refers to the aircraft's initial response when disturbed from a given AOA, slip, or bank.

- *Positive static stability*—the initial tendency of the aircraft to return to the original state of equilibrium after being disturbed (*Figure 4-2*)
- *Neutral static stability*—the initial tendency of the aircraft to remain in a new condition after its equilibrium has been disturbed (*Figure 4-2*)
- *Negative static stability*—the initial tendency of the aircraft to continue away from the original state of equilibrium after being disturbed (*Figure 4-2*)

DYNAMIC STABILITY

Static stability has been defined as the initial tendency to return to equilibrium that the aircraft displays after being disturbed from its trimmed condition.

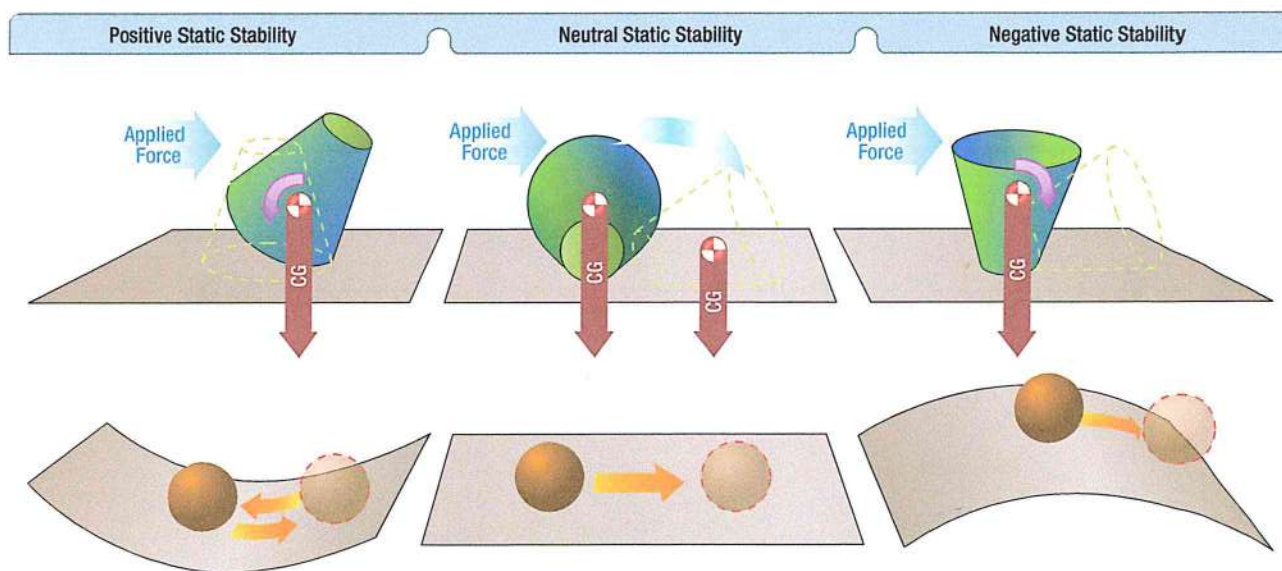

Figure 4-2. Three types of static stability.

Occasionally, the initial tendency is different or opposite from the overall tendency, so a distinction must be made between the two. *Dynamic stability* refers to the aircraft response over time when disturbed from a given AOA, slip, or bank. This type of stability also has three subtypes: (Figure 4-3)

- Positive dynamic stability—over time, the motion of the displaced object decreases in amplitude and, because it is positive, the object displaced returns toward the equilibrium state.
- Neutral dynamic stability—once displaced, the displaced object neither decreases nor increases in amplitude. A worn automobile shock absorber exhibits this tendency.
- Negative dynamic stability—over time, the motion of the displaced object increases and becomes more divergent.

LONGITUDINAL STABILITY (PITCHING)

In designing an aircraft, a great deal of effort is spent in developing the desired degree of stability around all three axes. But longitudinal stability about the lateral axis is considered to be the most affected by certain variables in various flight conditions.

Longitudinal stability is the quality that makes an aircraft stable about its lateral axis. It involves the pitching motion as the aircraft's nose moves up and down in flight. A longitudinally unstable aircraft has a tendency to dive or climb progressively into a very steep dive or climb, or even a stall. Thus, an aircraft with longitudinal instability becomes difficult and sometimes dangerous to fly. Static longitudinal stability or instability in an aircraft, is dependent upon three factors:

1. Location of the wing with respect to the CG.
2. Location of the horizontal tail surfaces with respect to the CG.
3. Area or size of the tail surfaces.

In analyzing stability, it should be recalled that a body free to rotate always turns about its CG.

4. To obtain static longitudinal stability, the relation of the wing and tail moments must be such that, if the moments are initially balanced and the aircraft is suddenly nose up, the wing moments and tail moments change so that the sum of their forces provides an unbalanced but restoring moment which, in turn, brings the nose down again. Similarly, if the aircraft is nose down, the resulting change in moments brings the nose back up.

Stability in an aircraft affects two areas significantly:

- Maneuverability—the quality of an aircraft that permits it to be maneuvered easily and to withstand the stresses imposed by maneuvers. It is governed by the aircraft's weight, inertia, size and location of flight controls, structural strength, and powerplant. It too is an aircraft design characteristic.
- Controllability—the capability of an aircraft to respond to the pilot's control, especially with regard to flightpath and attitude. It is the quality of the aircraft's response to the pilot's control application when maneuvering the aircraft, regardless of its stability characteristics.

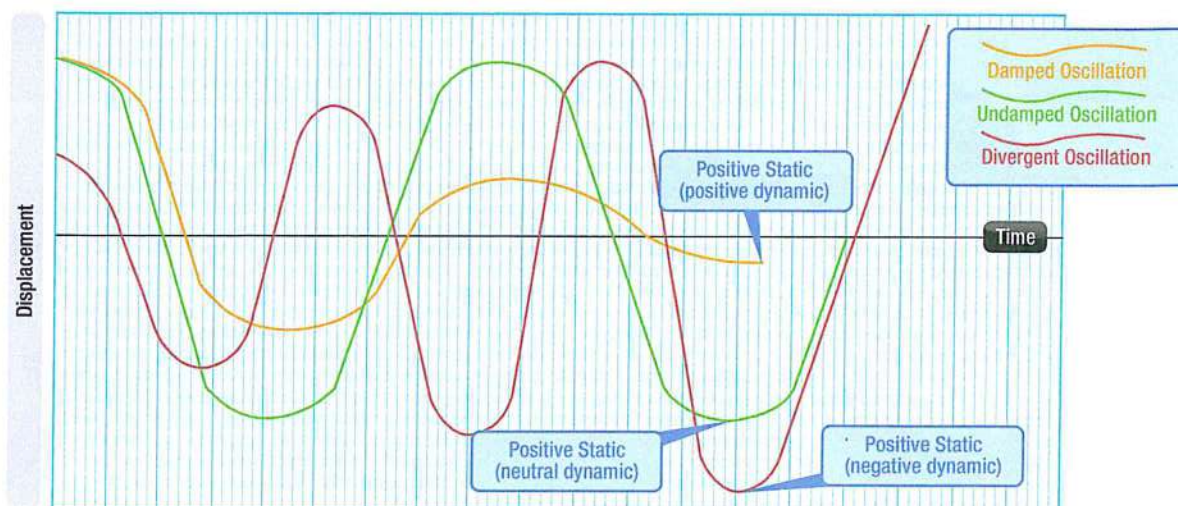

Figure 4-3. Damped versus undamped stability.

The Center of Lift (CL) in most asymmetrical airfoils has a tendency to change its fore and aft positions with a change in the AOA. The center of lift tends to move forward with an increase in AOA and to move aft with a decrease in AOA. This means that when the AOA of an airfoil is increased, the center of lift, by moving forward, tends to lift the leading edge of the wing still more. This tendency gives the wing an inherent quality of instability. (Note: center of lift is also known as the Center of Pressure (CP)).

Figure 4-4 shows an aircraft in straight-and-level flight. The line CG-CL-T represents the aircraft's longitudinal axis from the CG to a point T on the horizontal stabilizer.

Most aircraft are designed so that the wing's CL is to the rear of the CG. This makes the aircraft "nose heavy" and requires that there be a slight downward force on the horizontal stabilizer in order to balance the aircraft and keep the nose from continually pitching downward. Compensation for this nose heaviness is provided by setting the horizontal stabilizer at a slight negative AOA. The downward force thus produced holds the tail down, counterbalancing the "heavy" nose. It is as if the line CG-CL-T were a lever with an upward force at CL and two downward forces balancing each other, one a strong force at the CG point and the other, a much lesser force, at point T (downward air pressure on the stabilizer). To better visualize this physics principle: If an iron bar were suspended at point CL, with a heavy weight hanging on it at the CG, it would take downward pressure at point T to keep the "lever" in balance.

Even though the horizontal stabilizer may be level when the aircraft is in level flight, there is a downwash of air from the wings. This downwash strikes the top of the stabilizer and produces a downward pressure, which at

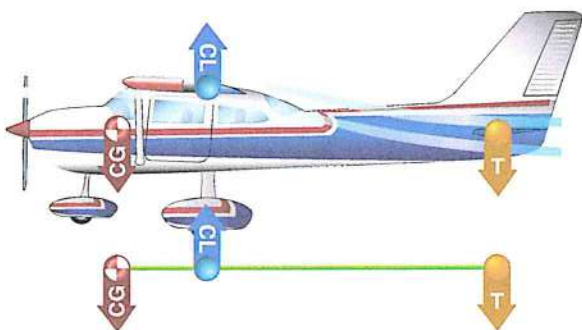

Figure 4-4. Longitudinal stability.

a certain speed is just enough to balance the "lever." The faster the aircraft is flying, the greater this downwash and the greater the downward force on the horizontal stabilizer (except T-tails). (Figure 4-5) In aircraft with fixed-position horizontal stabilizers, the aircraft manufacturer sets the stabilizer at an angle that provides the best stability (or balance) during flight at the design cruising speed and power setting.

If the aircraft's speed decreases, the speed of the airflow over the wing is decreased. As a result of this decreased flow of air over the wing, the downwash is reduced, causing a lesser downward force on the horizontal stabilizer. In turn, the characteristic nose heaviness is accentuated, causing the aircraft's nose to pitch down more. (Figure 4-6)

This places the aircraft in a nose-low attitude, lessening the wing's AOA and drag and allowing the airspeed to increase. As the aircraft continues in the nose-low attitude and its speed increases, the downward force on the horizontal stabilizer is once again increased. Consequently, the tail is again pushed downward and the nose rises into a climbing attitude.

As this climb continues, the airspeed again decreases, causing the downward force on the tail to decrease until the nose lowers once more. Because the aircraft is dynamically stable, the nose does not lower as far this

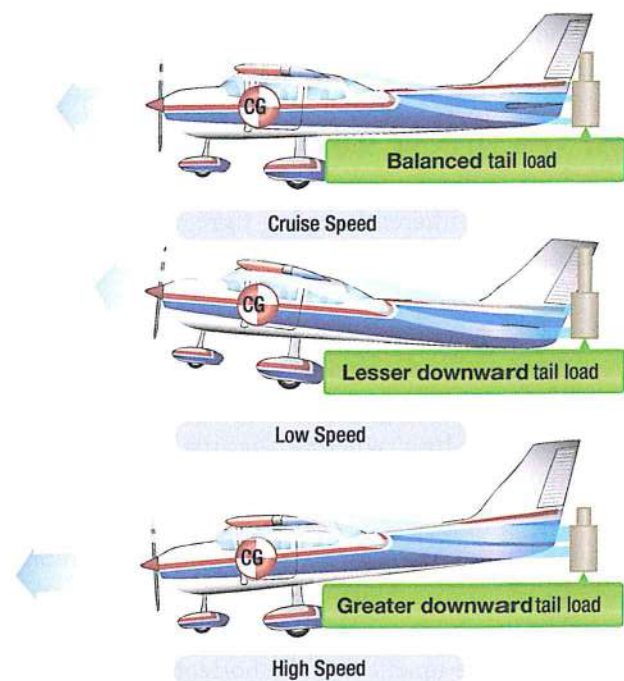

Figure 4-5. Effect of speed on downwash.

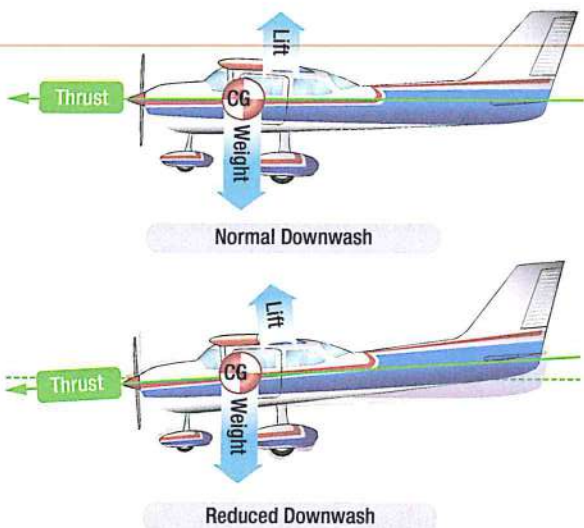

Figure 4-6. Reduced power allows pitch down.

time as it did before. The aircraft acquires enough speed in this more gradual dive to start it into another climb, but the climb is not as steep as the preceding one.

After several of these diminishing oscillations, in which the nose alternately rises and lowers, the aircraft finally settles down to a speed at which the downward force on the tail exactly counteracts the tendency of the aircraft to dive. When this condition is attained, the aircraft is once again in balanced flight and continues in stabilized flight as long as this attitude and airspeed are not changed.

A similar effect is noted upon closing the throttle. The downwash of the wings is reduced and the force at T in *Figure 4-4* is not enough to hold the horizontal stabilizer down. It seems as if the force at T on the lever were allowing the force of gravity to pull the nose down. This is a desirable characteristic because the aircraft is inherently trying to regain airspeed and reestablish the proper balance.

Power or thrust can also have a destabilizing effect in that an increase of power may tend to make the nose rise. The aircraft designer can offset this by establishing a "high thrust line" wherein the line of thrust passes above the CG. (*Figures 4-7 and 4-8*)

In this case, as power or thrust is increased a moment is produced to counteract the down load on the tail. On the other hand, a very "low thrust line" would tend to add to the nose-up effect of the horizontal tail surface.

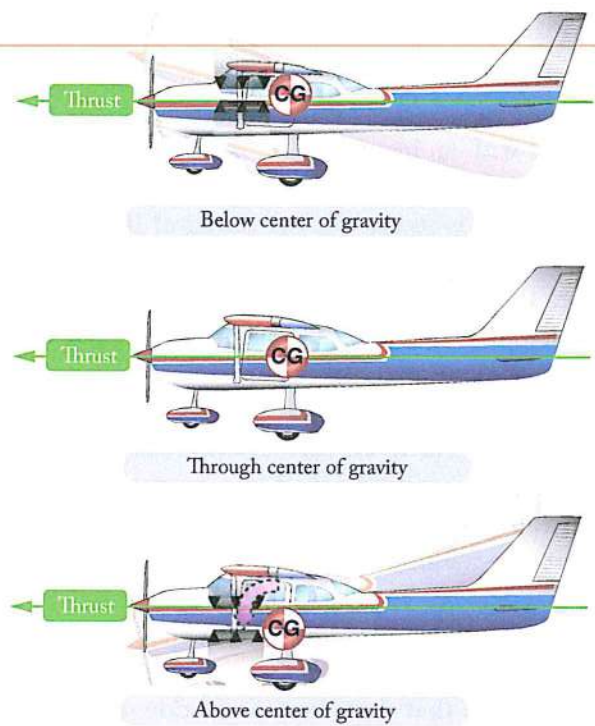

Figure 4-7. Thrust line affects longitudinal stability.

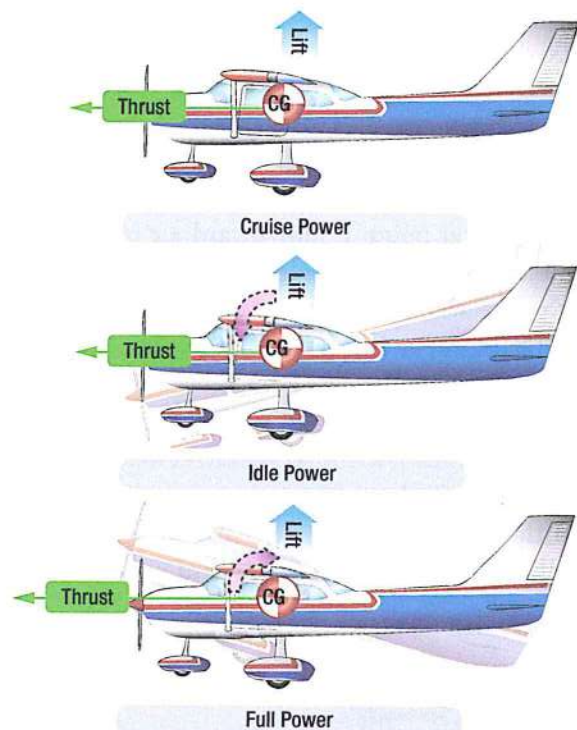

Figure 4-8. Power changes affect longitudinal stability.

Conclusion: with center of gravity forward of the center of lift and with an aerodynamic tail-down force, the aircraft usually tries to return to a safe flying attitude.

LATERAL STABILITY (ROLLING)

Stability about the aircraft's longitudinal axis, which extends from the nose of the aircraft to its tail, is called *lateral stability*. This helps to stabilize the lateral or "rolling effect" when one wing gets lower than the wing on the opposite side of the aircraft. There are four main design factors that make an aircraft laterally stable: dihedral, sweepback, keel effect, and weight distribution.

DIHEDRAL

The most common procedure for producing lateral stability is to build the wings with an angle of one to three degrees above perpendicular to the longitudinal axis. The wings on either side of the aircraft join the fuselage to form a slight V or angle called "*dihedral*." The amount of dihedral is measured by the angle made by each wing above a line parallel to the lateral axis.

Dihedral involves a balance of lift created by the wings' AOA on each side of the aircraft's longitudinal axis. If a momentary gust of wind forces one wing to rise and the other to lower, the aircraft banks. When the aircraft is banked without turning, the tendency to sideslip or slide downward toward the lowered wing occurs. (*Figure 4-9*)

Since the wings have dihedral, the air strikes the lower wing at a much greater AOA than the higher wing. The increased AOA on the lower wing creates more lift than the higher wing. Increased lift causes the lower wing to begin to rise upward. As the wings approach the level position, the AOA on both wings once again are equal, causing the rolling tendency to subside. The effect of dihedral is to produce a rolling tendency to return the aircraft to a laterally balanced flight condition when a sideslip occurs.

The restoring force may move the low wing up too far, so that the opposite wing now goes down. If so, the process is repeated, decreasing with each lateral oscillation until a balance for wings-level flight is finally reached.

Conversely, excessive dihedral has an adverse effect on lateral maneuvering qualities. The aircraft may be so stable laterally that it resists an intentional rolling motion. For this reason, aircraft that require fast roll or banking characteristics usually have less dihedral than those designed for less maneuverability.

SWEEPBACK

Sweepback is an addition to the dihedral that increases the lift created when a wing drops from the level position. A sweptback wing is one in which the leading edge slopes backward. When a disturbance causes an aircraft with sweepback to slip or drop a wing, the low wing presents its leading edge at an angle that is perpendicular to the relative airflow. As a result, the low wing acquires more lift, rises, and the aircraft is restored to its original flight attitude.

Sweepback also contributes to directional stability. When turbulence or rudder application causes the aircraft to yaw to one side, the right wing presents a longer leading edge perpendicular to the relative airflow. The airspeed of the right wing increases and it acquires more drag than the left wing. The additional drag on the right wing pulls it back, turning the aircraft back to its original path.

KEEL EFFECT AND WEIGHT DISTRIBUTION

An aircraft always has the tendency to turn the longitudinal axis of the aircraft into the relative wind. This "weather vane" tendency is similar to the keel of a ship and exerts a steadying influence on the aircraft laterally about the longitudinal axis. When the aircraft is disturbed and one wing dips, the fuselage weight acts like a pendulum returning the airplane to its original attitude. Laterally stable aircraft are constructed so that the greater portion of the keel area is above and behind the CG. (*Figure 4-10*)

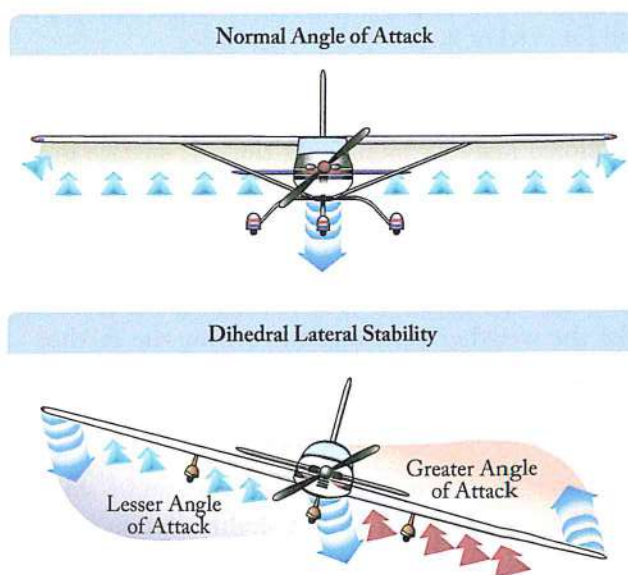

Figure 4-9. Dihedral for lateral stability.

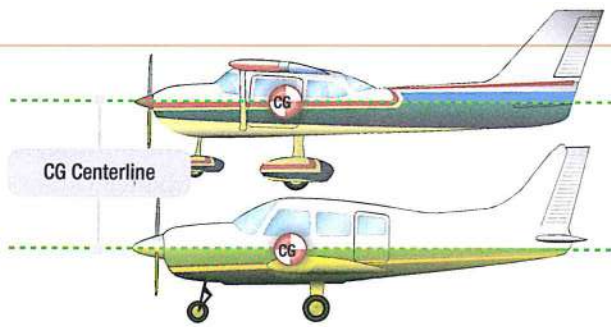

Figure 4-10. Keel area for lateral stability.

Thus, when the aircraft slips to one side, the combination of the aircraft's weight and the pressure of the airflow against the upper portion of the keel area (both acting about the CG) tends to roll the aircraft back to wings-level flight.

VERTICAL (DIRECTIONAL) STABILITY (YAWING)

Stability about the aircraft's vertical axis (the sideways moment) is called *yawing* or *directional stability*. Yawing or directional stability is the most easily achieved stability in aircraft design. The area of the vertical fin and the sides of the fuselage aft of the CG are the prime contributors which make the aircraft act like the well known weather vane or arrow, pointing its nose into the relative wind.

In examining a weather vane, it can be seen that if exactly the same amount of surface were exposed to the wind in front of the pivot point as behind it, the forces fore and aft would be in balance and little or no directional movement would result. Consequently, it is necessary to have a greater surface aft of the pivot point than forward of it.

Similarly, the aircraft designer must ensure positive directional stability by making the side surface greater aft than ahead of the CG. (Figure 4-11) To provide additional positive stability to that provided by the fuselage, a vertical fin is added. The fin acts similar to the feather on an arrow in maintaining straight flight. Like the weather vane and the arrow, the farther aft this fin is placed and the larger its size, the greater the aircraft's directional stability.

If an aircraft is flying in a straight line, and a sideward gust of air gives the aircraft a slight rotation about its vertical axis (e.g., the right), the motion is retarded and stopped by the fin because while the aircraft is rotating

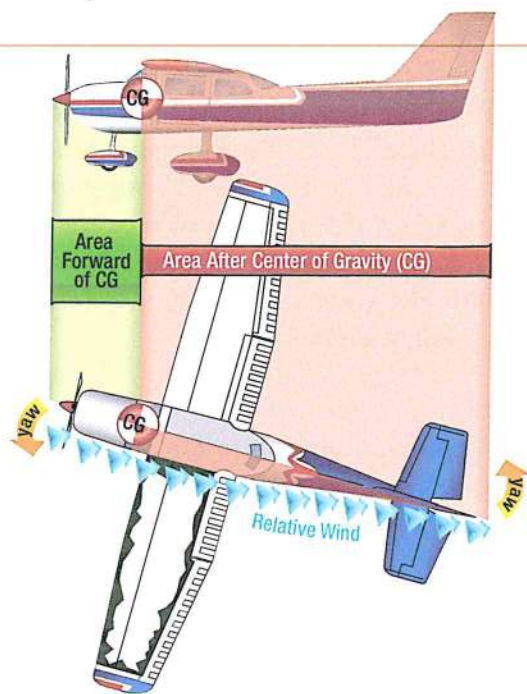

Figure 4-11. Fuselage and fin for directional stability.

to the right, the air is striking the left side of the fin at an angle. This causes pressure on the left side of the fin, which resists the turning motion and slows down the aircraft's yaw. In doing so, it acts somewhat like the weather vane by turning the aircraft into the relative wind. The initial change in direction of the aircraft's flightpath is generally slightly behind its change of heading. Therefore, after a slight yawing of the aircraft to the right, there is a brief moment when the aircraft is still moving along its original path, but its longitudinal axis is pointed slightly to the right.

The aircraft is then momentarily skidding sideways, and during that moment (since it is assumed that although the yawing motion has stopped, the excess pressure on the left side of the fin still persists) there is necessarily a tendency for the aircraft to be turned partially back to the left. There is a momentary restoring tendency caused by the fin.

This restoring tendency is relatively slow in developing and ceases when the aircraft stops skidding. When it ceases, the aircraft is flying in a direction slightly different from the original direction. It will not return of its own accord to the original heading; the pilot must reestablish the initial heading.

A minor improvement of directional stability may be obtained through sweepback. Sweepback is incorporated

in the design of the wing primarily to delay the onset of compressibility during high-speed flight. In lighter and slower aircraft, sweepback aids in locating the center of pressure in the correct relationship with the CG. A longitudinally stable aircraft is built with the center of pressure aft of the CG.

Because of structural reasons, aircraft designers sometimes cannot attach the wings to the fuselage at the exact desired point. If they had to mount the wings too far forward, and at right angles to the fuselage, the center of pressure would not be far enough to the rear to result in the desired amount of longitudinal stability. By building sweepback into the wings, however, the designers can move the center of pressure toward the rear. The amount of sweepback and the position of the wings then place the center of pressure in the correct location.

The contribution of the wing to static directional stability is usually small. The swept wing provides a stable contribution depending on the amount of sweepback, but the contribution is relatively small when compared with other components.

FREE DIRECTIONAL OSCILLATIONS (DUTCH ROLL)

Dutch roll is a coupled lateral/directional oscillation that is usually dynamically stable but is unsafe in an aircraft because of the oscillatory nature. The damping of the oscillatory mode may be weak or strong depending on the properties of the particular aircraft.

If the aircraft has a right wing pushed down, the positive sideslip angle corrects the wing laterally before the nose is realigned with the relative wind. As the wing corrects the position, a lateral directional oscillation can occur resulting in the nose of the aircraft making a figure eight on the horizon as a result of two oscillations (roll and yaw), which, although of about the same magnitude, are out of phase with each other.

In most modern aircraft, except high-speed swept wing designs, these free directional oscillations usually die out automatically in very few cycles unless the air continues to be gusty or turbulent. Those aircraft with continuing Dutch roll tendencies are usually equipped with gyro-stabilized yaw dampers. Manufacturers try to reach a midpoint between too much and too little directional stability. Because it is more desirable for the aircraft to have "spiral instability" than Dutch roll tendencies, most aircraft are designed with that characteristic.

QUESTIONS

Question: 4-1

Name the three axes of an aircraft.

Question: 4-5

An increase in wing _____ increases the lateral stability of the aircraft in flight.

Question: 4-2

Static longitudinal stability of an aircraft depends on what three things?

Question: 4-6

Stability about the vertical axis of an aircraft is known as _____ or _____ stability.

ANSWERS

Answer: 4-1
longitudinal.
lateral.
vertical.

Answer: 4-3
dihedral.

Answer: 4-2
Location of the wing with respect to the CG
(center of gravity).
Location of the horizontal tail surfaces in
relation to the CG.
Area of the tail surfaces.

Answer: 4-4
yawing.
directional.

AMC	/	Acceptable Means of Compliance
AOA	/	Angle of Attack
CD	/	Drag Coefficient
C_D	/	Coefficient of Drag
CG	/	Center of Gravity
C_L	/	Lift Coefficient
CL	/	Center of Lift
C_{L-MAX}	/	Maximum Coefficient of Lift
CP	/	Center of Pressure
DP	/	Parasite Drag
EASA	/	European Aviation Safety Administration
GM	/	Guidance Material
Gs	/	Acceleration of Gravity
ICAO	/	International Civil Aviation Organization
ISA	/	International Standard Atmosphere
ISO	/	International Organization for Standardization
KCAS	/	Knots Calibrated Air Speed
L/D	/	Lift/Drag
L/D_{MAX}	/	Lift to Drag Ratio
MAC	/	Mean Aerodynamic Chord
ROT	/	Rate of Return
UV	/	Ultraviolet Rays
VMO/MMO	/	Maximum Operating Limit Speed

Acceleration. Increase in the rate or speed of something.

Aerodynamics. The study of the properties of moving air, and especially of the interaction between the air and solid bodies moving through it.

Airfoil. A structure with curved surfaces designed to give the most favorable ratio of lift to drag in flight, used as the basic form of the wings, fins, and horizontal stabilizer of most aircraft.

Angle of Attack. Is the angle between the oncoming air or relative wind and a reference line on the airplane or wing.

Angle of Incidence. The acute angle the wing chord makes with the longitudinal axis of the aircraft is called the angle of incidence, or the angle of wing setting.

Atmospheric Pressure. The pressure exerted by the weight of the atmosphere, which at sea level has a mean value of 101,325 pascals (roughly 14.6959 pounds per square inch).

Axis. There are three axes around which the airplane moves. These axes all pass through the airplane's center of gravity, which is that point which is the center of the airplane's total weight.

Boundary Layer. On an aircraft wing the boundary layer is the part of the flow close to the wing, where viscous forces distort the surrounding non-viscous flow.

Burble Point. When the AOA increases to the angle of maximum lift, the burble point is reached.

Center of Pressure. The point of intersection of the resultant force line with the chord line of the airfoil is called the center of pressure (CP).

Chord Line. A Chord Line is a line depicting the chord which extends forward of the leading edge.

Chord. The Chord of a wing is the width of the wing from the leading edge apex to the trailing edge.

Critical Angle. When the critical angle is reached, the air ceases to flow smoothly over the top surface of the airfoil and begins to burble or eddy. This means that air breaks away from the upper camber line of the wing.

Density. The density, or more precisely, the volumetric mass density, of a substance is its mass per unit volume.

Dihedral. The wings on either side of the aircraft join the fuselage to form a slight V or angle.

Directional Stability. Directional stability is associated with the realigning of the longitudinal axis with the flight path (the angle of zero slip) after a disturbance causes the aircraft to yaw out of alignment and produce slip.

Drag Rise. The drag divergence Mach number (not to be confused with critical Mach number) is the Mach number at which the aerodynamic drag on an airfoil or airframe begins to increase rapidly as the Mach number continues to increase. This increase can cause the drag coefficient to rise to more than ten times its low speed value.

Drag. The force that exerts a braking action to hold the aircraft back. Drag is a backward deterrent force and is caused by the disruption of the airflow by the wings, fuselage, and protruding objects.

Dutch Roll. Dutch roll is a type of aircraft motion, consisting of an out-of-phase combination of "tail-wagging" and rocking from side to side.

Dynamic Stability. the aircraft response over time when disturbed from a given AOA, slip, or bank.

Fineness Ratio. is defined as the ratio of the chord of the airfoil to its maximum thickness.

Flaps. Flaps are usually mounted on the wing trailing edges of a fixed-wing aircraft. Flaps are used to lower the minimum speed at which the aircraft can be safely flown, and to increase the angle of descent for landing.

Form Drag. Which results from the aerodynamic resistance to motion due to the shape of the aircraft.

GLOSSARY

Glide Angle. The angle between the plane of the horizon and the path of a glider or airplane; especially: the least angle at which a glider or airplane will glide to earth in still air.

Glide Ratio. The distance the airplane will, with power off, travel forward in relation to the altitude it loses.

Gravity or Weight. The force that pulls the aircraft toward the earth. Weight is the force of gravity acting downward upon everything that goes into the aircraft, such as the aircraft itself, crew, fuel, and cargo.

Gravity. Is the pulling force that tends to draw all bodies toward the center of the earth.

Humidity. A quantity representing the amount of water vapor in the atmosphere or a gas.

Interference Drag. Which occurs where surfaces with different flow characteristics meet (e.g. wing and fuselage).

Lateral Stability. Stability about the aircraft's longitudinal axis, which extends from the nose of the aircraft to its tail.

Lift Coefficient. Is a ratio between lift pressure and dynamic pressure and is a function of the shape of the wing and angle of attack.

Lift. The force that pushes the aircraft upward. Lift acts vertically and counteracts the effects of weight.

Load Factor. Load factors are also referred to as "limit load factors." For reasons of safety, it is required that the aircraft be designed to withstand load factors without any structural damage.

Longitudinal Stability. Is the quality that makes an aircraft stable on its lateral axis. It involves the pitching motion as the aircraft's nose moves up and down in flight.

Mach Number. The ratio of the true airspeed of the aircraft to the speed of sound in the same atmospheric conditions.

Mean Aerodynamic Chord. Is the average distance from the leading edge to the trailing edge of the wing. Due to the many wing planform designs, the mean aerodynamic chord is not necessarily half way from the fuselage to the wing tip as it is on a perfectly rectangular wing.

Parasite Drag. Parasite (parasitic) drag (DP) is defined as all drag that is not associated with the production of lift.

Planform. The outline of wing or tailplane when viewed from above.

Polar Curve. A graph which contrasts the sink rate of an aircraft with its horizontal speed.

Shock Wave. Typically associated with supersonic aircraft, however, they also form on an aircraft traveling at less than the speed of sound.

Skin Friction Drag. Which is related to the smoothness (or roughness) of the aircraft surfaces.

Speed. The rate at which someone or something is able to move or operate.

Stall Fence. Wing fences, also known as boundary layer fences and potential fences are fixed aerodynamic devices attached to aircraft wings. Often seen on swept-wing aircraft, wing fences are flat plates fixed to the upper surfaces parallel to the airflow, typically wrapping around the leading edge.

Stall. An aircraft stall results from a rapid decrease in lift caused by the separation of airflow from the wing's surface brought on by exceeding the critical AOA. A stall can occur at any pitch attitude or airspeed.

Static Stability. The initial tendency to return to equilibrium that the aircraft displays after being disturbed from its trimmed condition.

Subsonic. The term describes an aircraft that flies below its critical Mach number.

Supersonic. The term describes an aircraft that flies above its critical Mach number.

Sweepback. The angle at which an aircraft's wing is set back from a right angle to the body.

Thrust. The force that moves the aircraft forward. Thrust is the forward force produced by the powerplant that overcomes the force of drag.

Transition Point. At the transition point, the character of the airflow changes and the laminar boundary layer quickly becomes a turbulent boundary layer. This turbulent boundary layer continues to thicken downstream.

Velocity. The speed of something in a given direction.

Vortex Generators. Is an aerodynamic device, consisting of a small vane usually attached to a lifting surface, such as an aircraft wing.

Vortex. A mass of whirling fluid or air, especially a whirlpool or whirlwind.

Wave Drag. Is a force, or drag that retards the forward movement of an airplane, in both supersonic and transonic flight, as a consequence of the formation of shock waves.

Winglet. A small vertical surface at the tips of the wings. They help direct the turbulent airflow that all wings have at the tips. They make the wings more efficient.

Yawing. A yaw motion is a side to side movement of the nose of the aircraft. The yawing motion is being caused by the deflection of the rudder.

A		International Standard Atmosphere 1.6	
—		K	
Aerodynamic Forces in Turns 3.5		—	
Aerodynamic Resultant 2.10		Keel Effect and Weight Distribution 4.7	
Aerodynamics 2.2		L	
Aerodynamic Terms 2.7		—	
Airfoil Contamination 2.9		Lateral Stability (Rolling) 4.7	
Airfoils 2.8		Leading Edge Devices 3.17	
Angle of Attack (AOA) 2.12		Lift 3.2	
B		Lift and Drag Coefficients 2.11	
—		Lift Augmentation 3.16	
Basic Aerodynamics 1.2		Lift/Drag Ratio 2.11	
Bernoulli's Principle and Subsonic Flow 2.3		Load Factors 3.9	
Boundary Layer and Friction Effects 2.4		Load Factors in Aircraft Design 3.9	
D		Longitudinal Stability (Pitching) 4.4	
—		M	
Density 1.4		—	
Dihedral 4.7		Mach Number vs Airspeed 3.12	
Drag 2.14		N	
Drag and Airspeed 2.17		—	
F		Newton's Laws of Motion 2.2	
—		P	
Fixed Airflow Devices 3.18		—	
Flaps 3.16		Parasite Drag 2.14	
Flight Envelope and Structural Limitations 3.9		Physics of the Atmosphere 1.2	
Form Drag 2.14		Planform and Vortices 2.7	
Free Directional Oscillations (Dutch Roll) 4.9		Polar Curve 3.5	
Friction Drag 2.14		Pressure 1.2	
G		R	
—		—	
Generation of Lift and Drag 2.11		Relationship Between Lift, Weight, Thrust and Drag .. 3.2	
Glide Ratio 3.3		S	
H		—	
—		Shape of the Airfoil 2.9	
High Speed Flight 3.10		Shock Waves 3.13	
Humidity 1.4		Speed Ranges 3.11	
I		Stability and Control 4.3	
—		Stability (Yawing) 4.8	
Induced Drag 2.15		Stalls 3.7	
Interference Drag 2.15			

INDEX

Static Stability.....	4.3
Subsonic vs Supersonic Flow	3.10
Sweepback.....	3.14
Sweepback.....	4.7

T

Temperature and Altitude.....	1.5
The Axes of an Aircraft.....	4.2
Thrust and Drag.....	3.3
Thrust, Weight, Lift and Drag	2.10

V

Velocity and Acceleration.....	2.2
Vertical (Directional)	4.8

W

Wave Drag	2.16
Weight, Center of Gravity, Lift	3.2



+1 970 726 5111
www.actechbooks.com

72413 US Hwy 40
Tabernash, CO 80478-0270
USA

ISBN 978-0989754774



9 780989 754774